

Sense & Sensibility

ARCHE  
JET  
GLIDER System  
LOOPY  
TAKE-OFF  
UBLevo  
RECEPTION  
OFFICE FURNITURE MANUFACTURER







# History of men and earth

A due passi da Venezia, nella terra del Palladio, tra le Dolomiti e il Lago di Garda. Tra gli aeroporti di Venezia e Treviso nel cuore dell'operoso nord-est italiano. Cultura, storia, arte, paesaggio nel DNA dell'uomo e del lavoro.

A stone's throw from Venice, in architect Palladio land, between the Dolomites and Lake Garda. Between the Venice and Treviso airports, in the very heart of the industrious Italian north-east.

Where culture, history, art and beautiful landscapes are part of the DNA intrinsic to man and work.

À deux pas de Venise, dans la région de l'architecte Palladio, entre les Dolomites et le lac de Garde.

Entre les aéroports de Venise et Trévisé, au cœur du nord-est italien travailleur. La culture, l'histoire, l'art et le paysage dans l'ADN de l'homme et du travail.



Unweit von Venedig, in der Heimat des Palladio, zwischen den Dolomiten und dem Gardasee. Zwischen den Flughäfen Venedig und Treviso im Herzen des geschäftigen italienischen Nordostens. Kultur, Geschichte, Kunst, Landschaft in der DNA des Menschen und der Arbeit.

Op een steenworp van Venetië, in de zone van architect Palladio, tussen de Dolomieten en het Gardameer. Tussen de luchthavens van Venetië en Treviso, in het hartje van het zweogende Italiaanse Noord-Oosten. Cultuur, geschiedenis, kunst, landschap in het DNA van mens en werk.

A dos pasos de Venecia, en la tierra de Palladio, entre las Dolomitas y el Lago de Garda. Entre los aeropuertos de Venecia y Treviso, en el corazón del laborioso noreste italiano. Cultura, historia, arte, paisaje en el ADN del hombre y del trabajo.



# We are

Tecniche di produzione computerizzate con processi produttivi certificati ISO 9001 e con la certificazione ISO 14001, attenzione all'ambiente con l'utilizzo di pannelli ecologici e a bassa emissione di formaldeide, portano l'azienda in linea con la globalizzazione e l'internazionalità del mercato.

Computerised production techniques with productive processes ISO 9001 certified and with ISO 14001 certification; careful attention to the environment by virtue of the deployment of ecological panels, with low formaldehyde emission, these are all elements that bring the company in line with the market's globalisation and international standing.

L'entreprise répond à la globalisation et à l'internationalité du marché, grâce aux techniques de production par ordinateur, aux processus de production certifiés ISO 9001, avec la certification ISO 14001, et grâce à l'attention pour l'environnement en utilisant des panneaux écologiques, à faible émission de formaldéhyde.



Computergesteuerte Produktionstechniken mit der Zertifizierung ISO 9001 und mit der Zertifizierung ISO 14001 sowie die durch ökologische Paneele mit geringer Formaldehydemission zum Ausdruck gebrachte Umweltfreundlichkeit bringen das Unternehmen in Einklang mit der Globalisierung und Internationalität des Markts.

Dank zij gecomputeriseerde productietechnieken, productieprocessen met certificering ISO 9001 en de certificering ISO 14001, aandacht voor het milieu door gebruik van ecologische panelen met lage emissie van formaldehyde, volgt de firma de globalisatie en internationalisering van de markt.

Las técnicas de producción computarizadas con procesos productivos certificados ISO 9001 y con la certificación ISO 14001, y la atención al medioambiente con el uso de paneles ecológicos y con baja emisión de formaldehído, hacen que la empresa esté actualizada con la globalización y la internacionalización de los mercados.



# Manufacturing





Da due generazioni produciamo mobili per l'ufficio nei nostri stabilimenti. La profonda conoscenza dei materiali, la professionalità, il dinamismo creativo e imprenditoriale sono alla base del successo aziendale. Non solo produzione ma sintesi creative e capacità professionale.

Our plants have been manufacturing office furniture for two generations. The in-depth knowledge of materials, professionalism, creative and entrepreneurial dynamism are all at the base of the company's success. Not only productions, therefore, but creative syntheses and professional know-how.

Nous produisons des meubles pour le bureau dans nos établissements depuis deux générations. La connaissance profonde des matériaux, le professionnalisme, le dynamisme dans la création et dans l'entreprise, sont à la base du succès de notre société. Ce n'est pas seulement une question de production mais de synthèses créatives et d'aptitude professionnelle.

Seit zwei Generationen stellen wir in unseren Werken Büromöbel her. Der Erfolg des Unternehmens basiert auf einer gründlichen Kenntnis der Materialien, Professionalität und einem kreativen und unternehmerischen Dynamismus. Nicht nur Produktion, sondern auch kreative Synthese und professionelles Können.

Sinds twee generaties produceren wij kantoormeubelen in onze fabrieken. De grondige kennis van de materialen, de professionaliteit, het creatieve en ondernemende dynamisme liggen aan de basis van het succes van de firma. Niet enkel productie maar creatieve synthese en professionele bekwaamheid.

Hace dos generaciones que producimos muebles para oficina en nuestras fábricas. El profundo conocimiento de los materiales, el profesionalismo, el dinamismo creativo y empresarial representan la base del éxito de nuestra empresa. No solamente producción, sino también síntesis creativas y capacidad profesional.





design arch. Perin & Topan

# Contents

Arche pag. 012

Jet pag. 036

Loopy pag. 050

Glider System pag. 078

Take-Off pag. 110

Ubi Evo - M10 pag. 110

Reception pag. 130



# Arche

L'arredo contemporaneo riscopre le proporzioni dell'arte classica. Forme senza tempo si trasformano immediatamente in simboli della modernità. Dettagli, eleganza formale, materiali pregiati, essenze ed esclusive pelli sono gli elementi che caratterizzano Arche.

Contemporary furnishing re-discovers the proportions of classical art. Timeless shapes transform immediately into symbols of modernity. Detail, formal elegance, rich materials, wood and exclusive leather are the elements that characterise the Arche range.

L'ameublement contemporain redécouvre les proportions de l'art classique. Des formes sans âge se transforment immédiatement en des symboles de modernité. Des détails, des formes élégantes, des matières luxueuses, des bois et des cuirs de grande qualité, ce sont tous ces éléments qui distinguent Arche.

Die zeitgemäße Einrichtung entdeckt die Proportionen der klassischen Kunst neu. Zeitlose Formen verwandeln sich unmittelbar in Symbole der Modernität. Details, Eleganz der Form, kostbare Materialien, Holz und exklusives Leder – dies sind die Elemente, die kennzeichnend für Arche sind.

Het hedendaagse meubilair herontdekt de verhoudingen van de klassieke kunst. Tijdloze vormgeving veranderen onmiddellijk in symbolen van de moderniteit. Details, formele elegantie, edele materialen, essenties exclusief leder zijn de kenmerkende elementen van Arche.

La decoración contemporánea redescubre las proporciones del arte clásico. Formas sin tiempo se transforman inmediatamente en símbolos de la modernidad. Detalles, elegancia formal, materiales preciosos, esencias y pieles exclusivas son los elementos que caracterizan Arche.





Preziosa pelle abbinata all'essenza legno, materiali nobili, il gioco delle accurate cuciture tracciano i confini di un prodotto legato alla tradizione artigianiana.

Rich leather combined with precious woods and fine materials, the play of perfect stitching trace the profile of a product that has its roots in the tradition of craftsmanship.

Cuir de qualité assorti au bois précieux, matières nobles, le jeu de coutures raffinées trace les contours d'un produit lié à la tradition artisanale.

Kostbares Leder in Kombination mit Holz, edle Materialien, das Spiel der akkuraten Nähte umreißen die Grenzen eines an die handwerkliche Tradition gebundenen Produkts.

Edel leder gecombineerd met houtessentie, nobele materialen, en het spel van de welverzorgde stikkingen tekenen de grenzen af van een product van de ambachtelijke traditie.

Piel preciosa combinada con la esencia de madera, materiales nobles, el juego de las cuidadosas costuras marcan los límites de un producto relacionado con la tradición artesanal.











Ogni elemento d'arredo, ogni accessorio, tutto concorre alla costruzione di un ambiente polifunzionale che parla di comunicazione, interattività ed efficienza.

Each furnishing element, each accessory, all concur in the building of a multi-functional environment that promotes communication, interactivity and efficiency.

Chaque élément de décoration, chaque accessoire participe à la construction d'un environnement polyfonctionnel, qui parle de communication, d'interactivité e d'efficacité.



Jedes Einrichtungselement, jedes Accessoire – alles trägt dazu bei, ein polyfunktionelles Ambiente zu bilden, das Kommunikation, Interaktivität und Effizienz zum Ausdruck bringt.

Elk deel van het meubilair, elk accessoire vormt, een polyfunctionele ruimte, die communicatie, interactiviteit en efficiëntie bevordert.

Cada elemento de decoración, cada accesorio, todo eso contribuye a la construcción de un ambiente polifuncional que habla de comunicación, interactividad y eficiencia.













La scelta del tavolo riunione significa coniugare funzionalità ed estetica. Arche garantisce l'eleganza della soluzione con il massimo della componibilità.

The choice of the conference table implies the matching of functionality and aesthetics.

Arche guarantees the solution's elegance combined with maximum modularity.

Le choix de la table de réunion signifie savoir allier fonctionnalité et esthétisme. Arche garantit l'élégance de cette solution, tout en offrant une grande modularité.

Die Wahl des Konferenztischs zeugt von der Fähigkeit, Funktionalität und Ästhetik zu verschmelzen. Arche garantiert die Eleganz der Lösung bei einem Höchstmaß von Zusammenstellungsmöglichkeiten.

De keuze van de vergadertafel staat voor het samenbrengen van functionaliteit en esthetica.

Arche garandeert de elegantie van de oplossing samen met een maximale samenstelbaarheid.

La elección de la mesa para reunión significa conjugar funcionalidad y estética.

También garantiza la elegancia de la solución con lo máximo de la componibilidad.

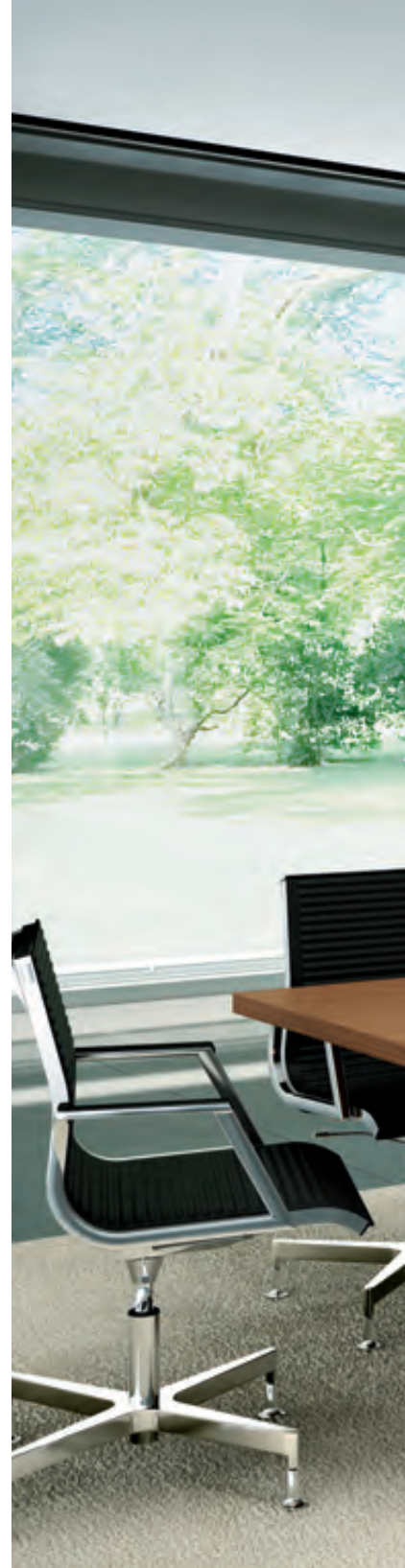



Il casellario fa da fondo al protagonista dello spazio.

Il grande tavolo interpreta con classe le esigenze della riunione.

The filing cabinet makes up the backdrop of the space's protagonist.

The large table stylishly interprets the demands of the conference.

Le casier sert de cadre au protagoniste de l'espace:

La grande table interprète, avec classe, les exigences de la salle de réunion.



Der Gitterkasten fungiert als Hintergrund für den Protagonisten des Raums.  
Der große Tisch interpretiert die Ansprüche der Konferenz mit Klasse.  
Het rek vormt de achtergrond van de protagoniste van de ruimte. De grote tafel  
interpreteert met klasse de vereisten van een vergaderzaal.  
El casillero hace de fondo a la protagonista del espacio.  
La gran mesa interpreta con clase las exigencias de la reunión.





Il rapporto di tecnica e proporzioni esalta l'eleganza e la bellezza delle linee pulite che costituiscono la gamba pannellata e alle varie soluzioni di pannellature frontali e laterali.

The technique and proportions ratio enhances the elegance and beauty of the clean lines that make up the panelled leg and the various front and lateral panelling solutions.

Le rapport entre technique et proportions exalte l'élégance et la beauté des lignes nettes qui constituent le piètement à panneau, et les différentes solutions de panneaux frontaux et latéraux.

Das Verhältnis zwischen Technik und Porportionen unterstreicht die Eleganz und Schönheit der reinen Linien, die das mit Paneel versehene Bein bilden, sowie die der verschiedenen Lösungen der vorderen und seitlichen Paneele.

De relatie van tussen techniek en proporties verheft de elegantie en schoonheid van de zuivere lijnen van de met paneel bedekte poot en de verschillende mogelijkheden met frontale en laterale panelen.

La relación de técnica y proporciones destaca la elegancia y la belleza de las líneas limpias que constituyen la pata con paneles y las varias soluciones previstas para los paneles laterales y frontales.





Arche \_ 031





**WP**

Legno wenghè  
Wenghè wood  
Wenghè  
Wenghèholz  
Wenghè hout  
Madera wengé

**NP**

Legno Noce Americano  
Americano walnut wood  
Noyer Americano  
Americano Nußbaumholz  
Notenhout Americano  
Madera Nogal Americano

**CB**

Vetro Laccato Bianco  
White Glass  
Verre Blanc  
Weiß Glas  
Glas Wit  
Vidrio Blanco

**CN**

Vetro Laccato Nero  
Black Glass  
Verre Noir  
Schwarz Glas  
Glas Zwart  
Vidrio Negro

**CK**

Vetro Trasparente  
Transparent Glass  
Verre transparent  
Transparentes Glas  
Transparent glas  
Vidrio transparente



**SCRIVANIE E CONTENITORI**  
**DESKS AND CONTAINERS**  
**BUREAUX ET ARMOIRES**  
**SCHREIBTISCHE UND SCHRÄNKE**  
**BUREAUX EN KASTEN**  
**MESAS Y CONTENEDORES**

**LACCATI LUCIDI**  
**GLOSSY LACQUERED**  
**LAQUE BRILLANT**  
**GLÄZENDE LACKIERT**  
**GLANZEND GELAKT**  
**LACADO PULIDO**

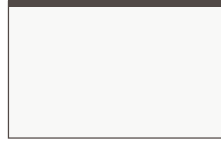

**UB** Laccato Bianco Lucido  
Glossy White Lacquered  
Laqué Blanc Brillant  
Glänzende Weiss Lackiert  
Glazend Lak Wit  
Lacado Blanco Pulido



**UN** Laccato Nebbia Lucido  
Glossy Fog Lacquered  
Laqué Brouillard Brillant  
Glänzende Nebel Lackiert  
Glazend Lak Mist  
Lacado Niebla Pulido



**UT** Laccato Tortora Lucido  
Glossy Tortora Lacquered  
Laqué Tortora Brillant  
Glänzende Tortora Lackiert  
Glazend Lak Tortora  
Lacado Tortora Pulido



**UA** Laccato Titanio Lucido  
Glossy Titanio Lacquered  
Laqué Titanio Brillant  
Glänzende Titanio Lackiert  
Glazend Lak Titanio  
Lacado Titanio Pulido

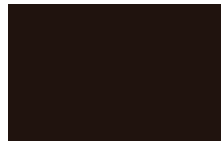

**UM** Laccato Moka Lucido  
Glossy Moka Lacquered  
Laqué Moka Brillant  
Glänzende Moka Lackiert  
Glazend Lak Moka  
Lacado Moika Pulido

**CUOIO - HIDE - CUIR**  
**HARTLEDER - HARD LEDER - CUERO**

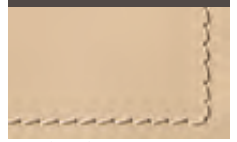

**QS** Cuoio Sabbia  
Sand Hide  
Cuir Sable  
Hartleder Sand  
Hard leder Zand  
Cuero Arena



**QC** Cuoio Cognac  
Cognac Hide  
Cuir Cognac  
Hartleder Cognac  
Hard leder Cognac  
Cuero Coñac

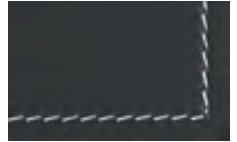

**QA** Cuoio Titanio  
Titanio Hide  
Cuir Titanio  
Hartleder Titanio  
Hard leder Titanio  
Cuero Titanio

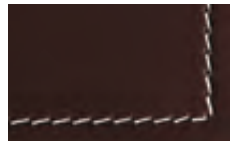

**QT** Cuoio Testa di Moro  
Dark Brown Hide  
Cuir Marron Foncé  
Hartleder Dunkelbraun  
Hard leder Donkerbruin  
Cuero Cabeza de Moro

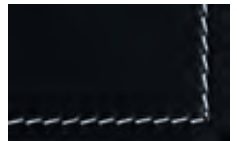

**QN** Cuoio Nero  
Black Hide  
Cuir Noir  
Hartleder Schwarz  
Hard leder Zwart  
Cuero Negra

SCRIVANIE - DESKS - BUREAUX - SCHREIBTISCHE - BUREAUS- ESCRITORIOS

**H. 73**

Piani da 18 mm - 18 mm worktops - Plan de travail 18 mm  
Schreibtischplatten 18 mm - Bureaublader 18 mm - Planos 18 mm

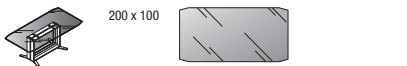
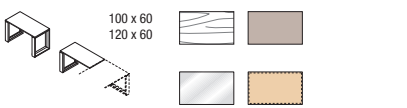
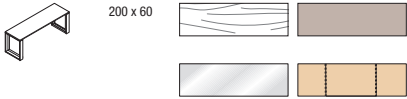
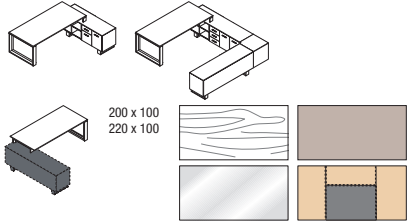
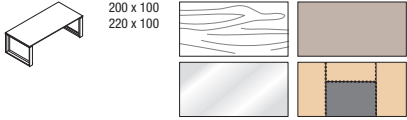

**H. 75**

Piani da 38 mm - 38 mm worktops - Plan de travail 38 mm  
Schreibtischplatten 38 mm - Bureaublader 38 mm - Planos 38 mm

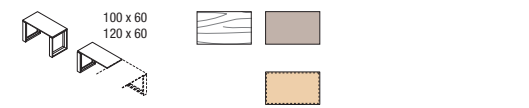
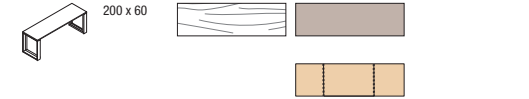
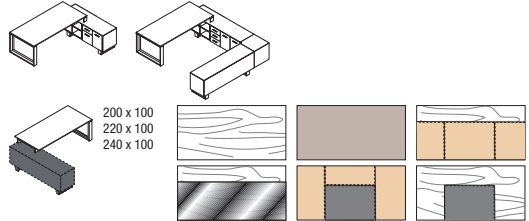
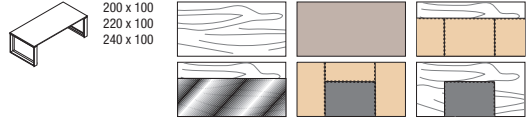

211 x 57 x 64h

169 x 57 x 64h

61 x 61 x 64h

211 x 57 x 64h

169 x 57 x 64h

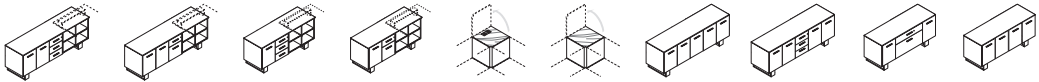

L. 200/220/240

94 x 1,9 x 62h

L. 200/220/240

91,5 x 2 x 38h

92 x 6 x 61h

120 x 80 x 75h

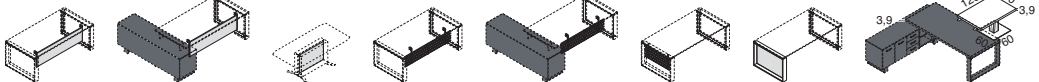

**ARMADI H. 78,8 - CABINETS - ARMOIRES**

SCHRÄNKE - KASTEN - ARMARIOS

L. 50

L. 100

**ARMADI H. 155,6 - CABINETS - ARMOIRES**

SCHRÄNKE - KASTEN - ARMARIOS

L. 50

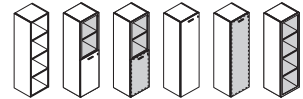
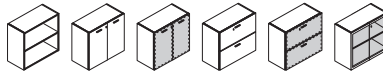
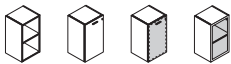

**ARMADI H. 194 - CABINETS - ARMOIRES**

SCHRÄNKE - KASTEN - ARMARIOS

L. 100

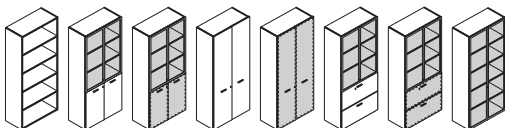

**ELEMENTI LIBRERIA - BOOKCASE MODULES**

ÉLÉMENTS DE LA BIBLIOTHÈQUE - ÉLEMENTE BÜCHERREGAL

ELEMENTEN BOEKENREK - ELEMENTOS BIBLIOTECA

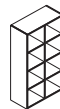

L. 100 x 155,6 H

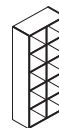

L. 100 x 194 H

**CASSETTIERE E MODULI DI SERVIZIO - PEDESTALS AND SERVICE MODULES - CAISSONS ET ELEMENTS DE SERVICE - CONTAINER UND MULTIFUNKTIONSCONTAINER LADEN-BLOKKEN EN SERVICEMODULEN - CAJONERAS Y ELEMENTOS DE SERVICIO**

44 x 57 x 57/63h

86 x 57 x 57/63h

127 x 57 x 57/63h

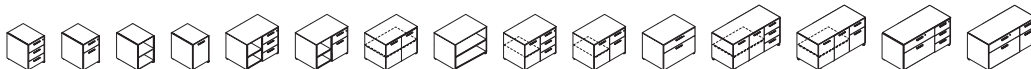

**CREDENZE - SIDEBOARDS - CROYANCES**

**GLAUBEN - GELOOF - CREENCIA**

127 x 57 x 74h

169 x 57 x 74h

211 x 57 x 74h

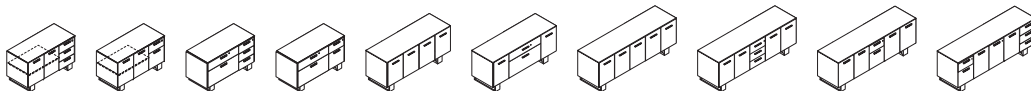

**BOISERIE - BOISERIE - BOISERIE**

**BOISERIE - BOISERIE - BOISERIE**

215 x 60 x 74h

223 x 46 x 196h

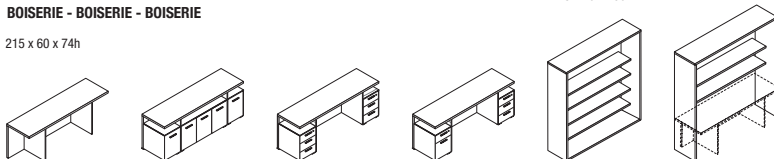

**TAVOLI RIUNIONE - MEETING TABLES - TABLES DE REUNION - KONFERENZTISCHE - CONFERENTIETAFEL - MESAS REUNIONES**

**H. 75**

Piani da 38 mm - 38 mm worktops - Plan de travail 38 mm  
Schreibtischplatten 38 mm - Bureaublader 38 mm - Planos 38 mm



Ø100/120

100 x 100  
120 x 120

210 x 100

240 x 120

120  
120  
120

120  
120  
120

160 x 120

320 x 120

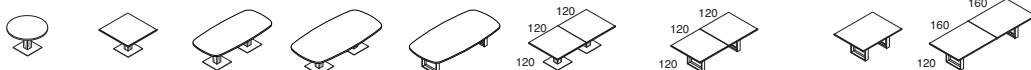

240 x 160

360 x 160

160 x 160

320 x 160

480 x 160

**TAVOLINI DA CAFFE' /  
COFFEE TABLE  
TABLE BASSE  
COUCHTISCH  
SALONTAFEL  
MESITA PARA CORTADO**

60 x 60  
120 x 60



L. 100

**ARMADI H. 194 - CABINETS - ARMOIRES**

**SCHRÄNKE - KASTEN - ARMARIOS**

L. 50

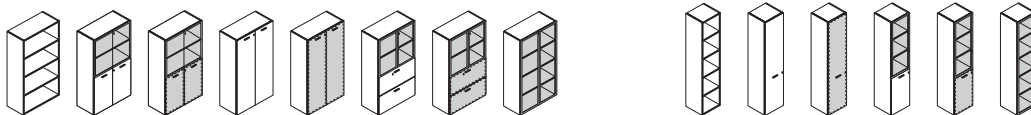

**TOP - TOP - TOP - ABDECKPLATTE  
TOPBLAD - PARTE SUPERIOR**

**FIANCHI DI CHIUSURA - CLOSING SIDES - FLANCS DE FINITION  
ABSCHLUSSFLANKEN - ZUPANELEN - COSTADOS DE CIERRE**





# Jet

Rigore formale, cura dei dettagli, attenzione al design e finiture prestigiose fanno di Jet un sistema direzionale che permette di comporre spazi d'arredo direzionali completi di piani lavoro, isole di conversazione, allunghi, cassettiere e mobili di servizio.

Formal restraint, attention to detail, meticulous design and prestigious finishes.

The Jet management office system offers executive office solutions complete with worktops, conversation areas, extensions, pedestals and storage units.

Rigueur formelle, soin des détails, attention pour le design et finitions prestigieuses font de Jet un ensemble de direction qui permet d'aménager des compositions avec plateaux, îlots de convivialité, tablettes, blocs-tiroirs et meubles de service.

Strenge der Form, Liebe zum Detail, Sorgfalt im Design und prestigeträchtige Finish-Ausführungen machen Jet zu einem Einrichtungssystem für das Direktionsbüro, das die Möglichkeit bietet, Kombinationen mit Arbeitsflächen, Gesprächsinseln, Verlängerungen, Schubladen- und Beistellmöbeln zu kreieren.

Strenge vormen, zorg voor de details, aandacht voor design en prestigieuze afwerkingen maken van Jet een systeem dat toestaat directiemeubelruimtes samen te stellen, met werkvlakken, alleenstaande conversatietafels, verlengingen, ladenkasten en opbergmeubels.

Rigor formal, cura de los detalles, atención al diseño y acabados prestigiosos hacen de Jet un sistema direccional que permite componer espacios de decoración direccionales completos con planos de trabajo, islas de conversación, extensiones, cajoneras y muebles de servicio.

Per soddisfare più tendenze, dal tradizionale all'innovativo, la scrivania è disegnata in due versioni strutturali: con quattro gambe e pannellata. Un progetto per arrivare ad un contenuto tecnologico avanzato.

The desk is available in two versions with different structural designs: with four legs or panelled sides to meet both traditional and innovative trends in design. This project offers a vast array of technologically advanced solutions.

Pour répondre à plusieurs tendances, aussi bien traditionnelle que moderne, la structure du bureau existe en deux versions: à quatre pieds et à panneaux. Un projet pour un contenu technologique d'avant-garde.



Um mehreren Tendenzen, von traditionell bis innovativ, zu entsprechen, bietet das Design des Schreibtischs zwei strukturelle Versionen: mit vier Beinen und in Paneel-Ausführung. Ein Projekt, mit dem ein fortgeschrittener technologischer Gehalt erzielt wird.

Om meerdere trends te bevredigen, van traditioneel tot innovierend, is de werktafel in twee structurele versies ontworpen: met vier poten en met panelen. Een project om een vooruitstrevende technologische inhoud te bereiken.

Para responder a varias tendencias, desde lo tradicional a lo innovador, el escritorio se ha diseñado en dos versiones estructurales: con cuatro patas y con panel. Un proyecto para obtener un contenido tecnológico avanzado.









Più tipologie di sostegno, più accessori per creare un'isola di lavoro sempre diversa ma coerente con privacy e funzione.  
Different types of supports and a range of accessories create a vast range of working islands providing privacy and practicality.  
Plusieurs types de piétements, plusieurs accessoires pour créer un îlot de travail toujours différent mais assurant à la fois confidentialité et fonctionnalité.

Mehrere Stütztypologien, mehrere Zubehör-Elemente, um eine stets unterschiedliche, jedoch mit Privacy und Funktion kohärente Arbeitsinsel zu schaffen.

Meerdere soorten steunen, meerdere accessoires om een alleenstaande werktafel te creëren die steeds verschillend is, maar tegelijkertijd coherent blijft met privacy en functie.

Un mayor número de tipos de soporte, un mayor número de accesorios para crear una isla de trabajo siempre diferentes, pero coherente con privacidad y función.











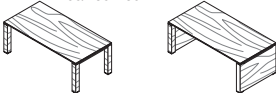

**H. 72**Piani da 18 mm - 18 mm worktops - Plan de travail 18 mm  
Schreibtischplatten 18 mm - Bureaublenden 18 mm - Planos 18 mm**H. 74**Piani da 38 mm - 38 mm worktops - Plan de travail 38 mm  
Schreibtischplatten 38 mm - Bureaublenden 38 mm - Planos 38 mm**SCRIVANIE - DESKS - BUREAU  
SCHREIBTISCHE - BUREAS - ESCRITORIO**180/200 x 100 x 72-74h  
160/180 x 80 x 72-74h**CONSOLE - CONSOLE - CONSOLE  
KONSOLE - CONSOLE - CONSOLA**

180/200 x 60 x 72-74h

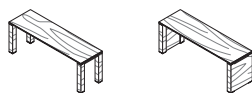
**DATTILO - ADDITIONAL DESK - DACTYLO  
ANBAUTISCH - HULPTAFEL - PLANO RETRAIBILE**

100 x 60 x 72-74h

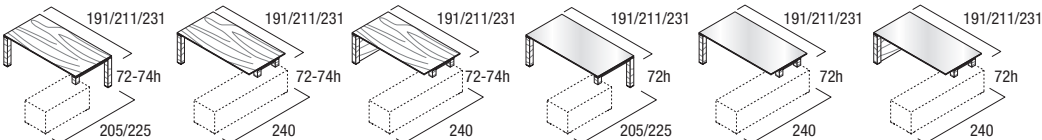
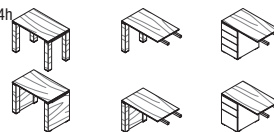
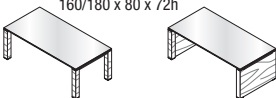
180/200 x 100 x 72h  
160/180 x 80 x 72h

180/200 x 60 x 72h

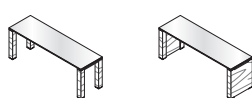

100 x 60 x 72h

**MOBILI DI SERVIZIO - SERVICE MODULES - MEUBLES DE SERVICE  
MULTIFUNKTIONSELEMENTE - SERVICEMODULEN - MEUBLE DE SERVICIO**

136,5 x 62,2 x 56,7h



136,5 x 62,2 x 63h



182 x 62,2 x 56,7h



227,5 x 62,2 x 56,7h

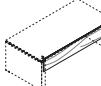

125/145/165 x 30

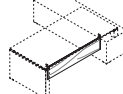

105/125/145 x 30

125/145/165 x 30

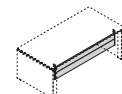

105/125/145 x 30

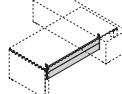
**RACCORDO - CONNECTOR  
RACCORD - VERBINDUNG  
HOKELEMENT - UNIÓN**

90 x 90

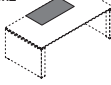

70x50x2

**TAVOLI RIUNIONE - MEETING TABLES - TABLES DE REUNION  
KONFERENZTISCHE - CONFERENTIETAFEL - MESAS REUNIONES**

100 x 100 x 74h

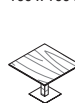

124 x 124 x 72-74h

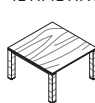

124 x 124 x 72h

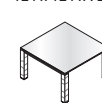

240 x 124 x 72-74h 240 x 124 x 72h 248 x 124 x 72-74h 248 x 124 x 72h 372 x 124 x 72-74h 372 x 124 x 72h 280/300/320 x 124 x 72-74h

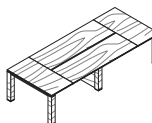
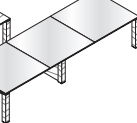
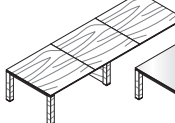
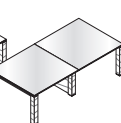
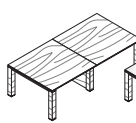
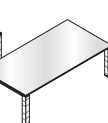
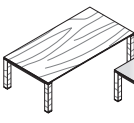
**TAVOLINI DA CAFFE' - COFFEE TABLE  
TABLE BASSE - COUCHTISCH  
SALONAFEL - MESITA PARA CORTADO**

60/120 x 60 x 40h

**CREDENZE - STORAGE UNIT - DESSERTERIE - BEISTELLMÖBEL - DRESSOIR - APARADOR**

103,6 x 46 x 72h

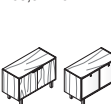

203,6 x 46 x 72h

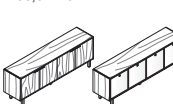

103,6 x 46 x 123h

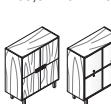

203,6 x 46 x 123h

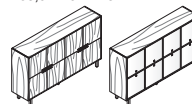



SCRIVANIE E CONTENITORI - DESKS AND CONTAINERS  
 BUREAUX ET ARMOIRES - SCHREIBTISCHE UND SCHRÄNK  
 BUREAUX EN KASTEN - MESAS Y CONTENEDORES

**WE**

Wengè  
 Wengè  
 Wengè  
 Wengè  
 Wengè  
 Wengè

**RN**

Rovere Naturale  
 Oak  
 Eiche  
 Eikenhout  
 Rouvre  
 Roble Natural

**NC**

Noce Canaletto  
 Canaletto walnut  
 Noyer Canaletto  
 Canaletto Nußbaum  
 Notenhout Canaletto  
 Nogal Canaletto

**CB**

Vetro Bianco  
 White Glass  
 Verre Blanc  
 Weiß Glas  
 Glas Wit  
 Vidrio Blanco

**CN**

Vetro Nero  
 Black Glass  
 Verre Noir  
 Schwarz Glas  
 Glas Zwart  
 Vidrio Negro

**CS**

Vetro Bisatinato  
 Glass crystal frosted on  
 both sides  
 Verre satiné sur les  
 deux faces  
 Beidseitig satiniertes  
 Glas  
 Tweezijdig gesatineerd  
 glas  
 Vidrio bisatinado



LACCATI - LACQUERED - LAQUÈS  
 LACKIERTES - GELAKT - LAQUEADO

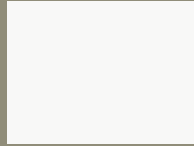

**LB** Laccato Bianco  
 White Laquered  
 Laqué Blanc  
 Weiß Lackiert  
 Wit Gelakt  
 Laqueado Blanco



**LF** Laccato Verde Natura  
 Verde Natura Lacquered  
 Laqué Verde Natura  
 Verde Natura Lackiert  
 Verde Natura Lak  
 Lacado Verde Natura

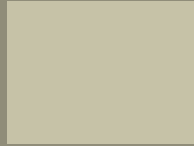

**L3** Laccato Nebbia  
 Fog Lacquered  
 Laqué Brouillard  
 Nebel Lackiert  
 Mist Lak  
 Lacado Niebla



**L5** Laccato Oceano  
 Oceano Lacquered  
 Laqué Oceano  
 Oceano Lackiert  
 Oceano Lak  
 Lacado Oceano



**L2** Laccato Tortora  
 Tortora Lacquered  
 Laqué Tortora  
 Tortora Lackiert  
 Tortora Lak  
 Lacado Tortora



**LE** Laccato Deep Teal  
 Deep Teal Lacquered  
 Laqué Deep Teal  
 Deep Teal Lackiert  
 Deep Teal Lak  
 Lacado Deep Teal



**L4** Laccato Titanio  
 Titanio Lacquered  
 Laqué Titanio  
 Titanio Lackiert  
 Titanio Lak  
 Lacado Titanio



**LR** Laccato Rosso Bordeaux  
 Bordeaux Lacquered  
 Laqué Bordeaux  
 Bordeaux Lackiert  
 Bordeaux Gelakt  
 Laqueado Burdeos

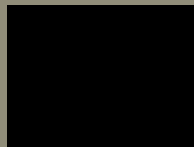

**LN** Laccato Nero  
 Black Lacquered  
 Laqué Noir  
 Schwarzlackiert  
 Zwart Gelakt  
 Laqueado Negro

VETRO - GLASS - VERRE  
 GLAS - GLAS - VIDRIO

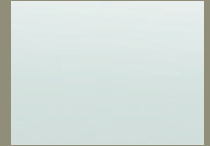

**CT** Vetro temperato satinato  
 Tempered glass satin  
 Verre trempé satiné  
 Temperiertes Glas mattier  
 Gehard glas gesatineerd  
 Vidrio templado satinado



**CO** Vetro temperato Tortora  
 Tortora tempered glass  
 Verre trempé Tortora  
 Tortora Temperiertes Glas  
 Gehard glas Tortora  
 Vidrio templado Tortora

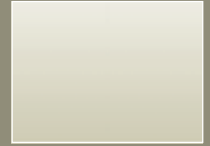

**CH** Vetro temperato Nebbia  
 Nebbia tempered glass  
 Verre trempé Nebbia  
 Nebbia Temperiertes Glas  
 Gehard glas Nebbia  
 Vidrio templado Nebbia

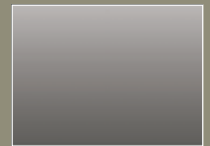

**CU** Vetro temperato Titanio  
 Titanio tempered glass  
 Verre trempé Titanio  
 Titanio Temperiertes Glas  
 Gehard glas Titanio  
 Vidrio templado Titanio



# Loopy

Il razionalismo conquista l'ufficio. Il fascino della purezza formale, l'uso delle strutture semplici e la rinnovata filosofia della funzionalità, mettono Loopy al centro delle attività operative e direttive nel posto lavoro.

Rationalism sweeps through the office. The fascination of formal purity, the use of simple structures and the renewed functionality philosophy, place Loopy at the core of operative and managerial activities in the work place.

Le rationalisme conquiert le bureau. Le charme de la pureté des formes, l'utilisation de structures simples et la philosophie renouvelée de la fonctionnalité, placent Loopy au centre des activités opérationnelles et directionnelles du poste de travail.

Der Rationalismus erobert das Büro. Die Faszination der Reinheit der Form, der Einsatz einfacher Strukturen und die neu interpretierte Philosophie der Funktionalität stellen Loopy in den Mittelpunkt der Abwicklungs- und Management-Aktivitäten am Arbeitsplatz.

De redelijkheid verovert het kantoor. De charme van de formele puurheid, het gebruik van simpele structuren en de hernieuwde filosofie van de functionaliteit, zetten Loopy in het centrum van de operatieve en leidinggevende werkzaamheden van de werkplaats.

El racionalismo conquista la oficina. La fascinación de la pureza formal, el uso de las estructuras simples y la filosofía renovada de la funcionalidad, meten Loopy en el centro de las actividades operativas y directivas en el puesto de trabajo.

Dall'operativo contrapposto ad alta valenza tecnologica, con gamba doppia bianca in colore col piano laminato, al direzionale dalle evocative trasparenze e riflessioni del cristallo e del cromato.

From the operative contrasting the high technological valence, with double white leg matching the colour of the laminated top, through to the managerial with evocative transparencies and glass-plate and chrome reflections.

Du secrétariat très technologique, avec piètement double blanc assorti au plateau lamifié, à la direction aux transparences évocatrices et aux reflets du verre et du chrome.

Vom gegenüberliegend angeordneten Modell mit hohem technologischen Gehalt und mit doppeltem weißen Bein, das farblich auf die Lamelliertplatte in abgestimmt ist, zur Direktionsausführung mit den beschwörenden Transparenzen und Reflexen des Kristalls und der Verchromung.

Vanuit het operatieve, tegengesteld tot de hoge technologische waarde, met dubbele witte poot, in dezelfde kleur als het galamineerd-vlak, naar het leidinggevende met evocatieve transparanties en reflecties van kristal en chroom.

Desde el operativo contrapuesto de alto valor tecnológico, con pata doble blanca con el mismo color usado para el plano laminado, al direccional con sus transparencias evocativas y los reflejos del cristal y del cromado.









La scrivania declinata in tutte le sue configurazioni, capace di adattare i piani di lavoro, dalla scrivania singola ai sistemi in linea o contrapposti, nella logica dello spazio e dell'evoluzione informatica.

The desk considered in all its configurations, capable of adapting the work tops, from the single desk to the in-line or back-to-back systems, in a flowing logic of space and of the evolution of information systems.

Le bureau se décline dans toutes ses configurations, en adaptant les plateaux, en partant du bureau individuel jusqu'aux systèmes accostés ou face à face, en respectant la logique de l'espace et l'évolution informatique.





Der in all seinen Konfigurationen abgewandelte Schreibtisch, mit der Fähigkeit, die Arbeitsflächen vom einzelnen Schreibtisch bis hin zu Reihen- oder Gegenüberstellungssystemen anzupassen, gemäß der Logik des Raums und der Evolution der Informatik.

De schrijftafel in al haar mogelijke vormen, die haar werkvlakken kan aanpassen van enkele schrijftafel tot in-lijn of tegenovergestelde systemen, volgens de logica van de ruimte en de informatieve evolutie.

El escritorio declinado en todas sus configuraciones, capaz de adaptar los planos de trabajo, desde el escritorio individual a los sistemas en línea o contrapuestos, en la lógica del espacio y de la evolución informática.



Le singole postazioni sono divise tra loro da elementi pannellati attrezzabili e da schermi sul piano lavoro. Soluzioni semplici ai quotidiani problemi di privacy e organizzazione dello spazio.

The single workstations are divided by panelled elements that can be equipped and by display screens on the work top. Simple solutions to the daily problems of privacy and space organisation.

Tous les postes sont séparés par des éléments à panneaux qui peuvent être équipés, ainsi que par des écrans sur le plan de travail. Ce sont des solutions simples aux problèmes quotidiens de l'intimité et de l'organisation de l'espace.

Die einzelnen Arbeitsplätze sind untereinander getrennt durch auszustattende Paneel-Elemente und Abschirmungen zur Arbeitsfläche hin. Einfache Lösungen für die täglichen Probleme der Privacy und räumlichen Organisation.

De aparte werkplaatsen zijn onderling verdeeld door uitrustbare panelen en schermen op het werkvlak. Eenvoudige oplossingen voor dagelijkse problemen van privacy en ruimtelijke organisatie.

Los puestos individuales se dividen mediante paneles que se pueden equipar y pantallas puestas en el plano de trabajo. Soluciones simples para los problemas diarios de privacidad y de organización del espacio.

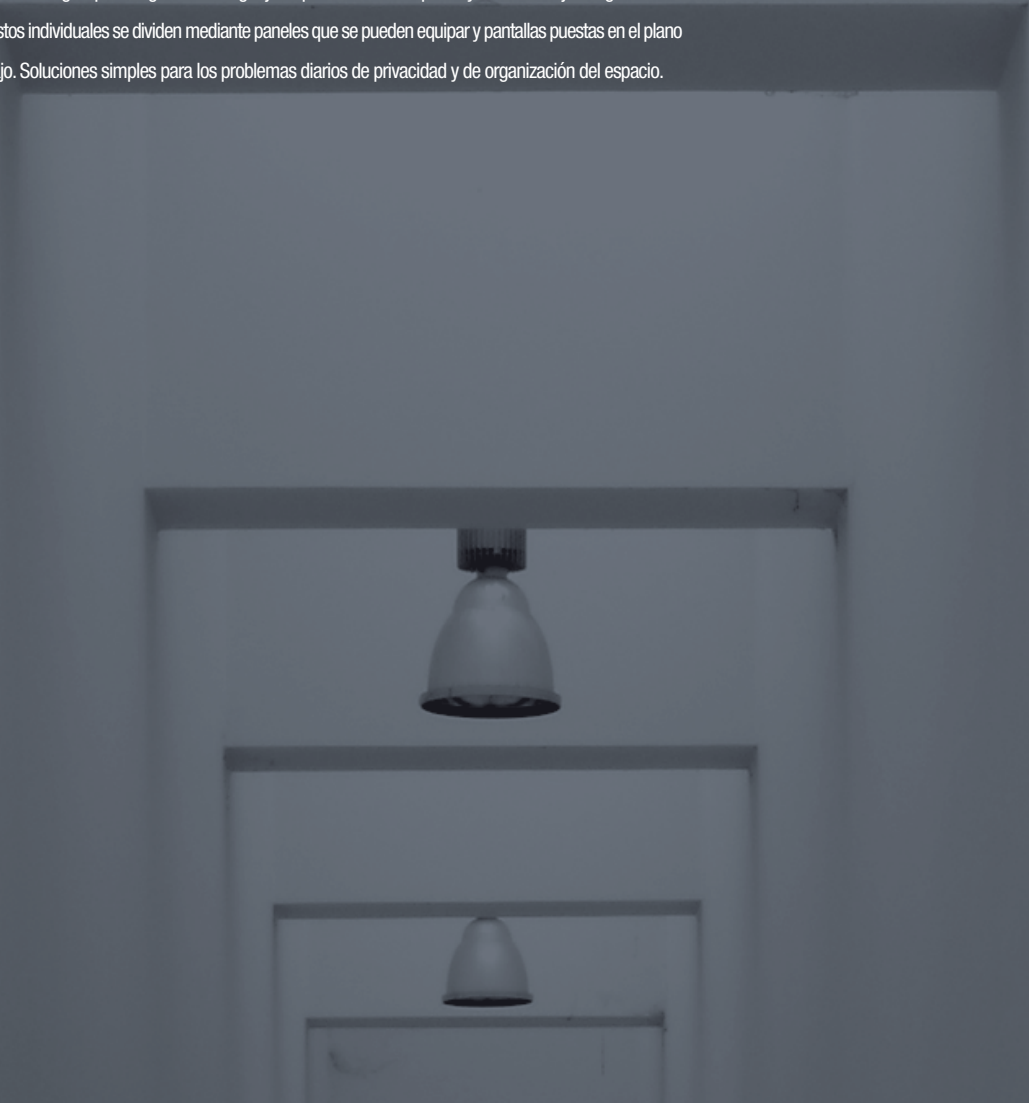











Dividere lo spazio non chiudersi nello spazio. Il posto di lavoro tra gli elementi modulari su ruote disponibili nel sistema Ubi.

Share space, don't close yourself into the space. The work station among the modular elements on castors available in the Ubi system.

Diviser l'espace et non pas se cloître dans l'espace. Le poste de travail parmi les éléments modulables sur roulettes, disponibles dans le système Ubi.

Den Raum teilen, sich nicht darin einschließen. Der Arbeitsplatz inmitten der modularen Elemente auf Rädern, die im System Ubi zur Verfügung stehen.

De ruimte verdelen zonder zich in de ruimte op te sluiten. De werkplaats tussen de modulaire elementen op wieltjes, beschikbaar in het systeem Ubi.

Dividir el espacio, no encerrarse en el espacio. El puesto de trabajo entre los elementos modulares sobre ruedas disponibles en el sistema Ubi.

Forme geometriche lineari e componibili costituiscono un elemento fondamentale per gestire e personalizzare in autonomia lo spazio lavoro.  
Linear and modular geometrical forms make up a fundamental element for managing and autonomously personalising working space.  
Les formes géométriques linéaires constituent un élément fondamental pour gérer et personnaliser, en toute autonomie, l'espace de travail.  
Lineare und kombinierbare geometrische Formen bilden ein grundlegendes Element, um den Arbeitsbereich autonom zu verwalten und individuell zu gestalten.  
Lineaire geometrische en samenstelbare vormen zijn een fundamenteel element om de werkruimte in autonomie te beheren en te verpersoonlijken.  
Formas geométricas lineales y componibles constituyen un elemento fundamental para administrar y personalizar autónomamente el espacio de trabajo.









Lo spazio riunione per esprimere idee con stile ed efficacia. Finiture dei piani e strutture metalliche per aggiungere un tocco di classe all'immagine aziendale.

The meeting area for expressing ideas is recognised by style and effectiveness. Special finishes for the tops and metallic structures to add a touch of class to the company image.

L'espace de réunion exprime les idées avec style et efficacité. Les finitions des plateaux et des structures métalliques ajoutent une touche de classe à l'image de l'entreprise.

Der Bereich für die Zusammenkunft, um Ideen mit Stil und Wirkungskraft vorzubringen. Die Finish-Ausführungen der Platten und die Metallstrukturen bereichern das Image des Unternehmens um einen Hauch von Klasse.

De vergaderruimte om met stijl en werkzaamheid ideeën uit te drukken. Afwerking van de vlakken en metalen structuren om een beetje klasse aan het beeld van de firma toe te voegen.

El espacio de reunión para expresar ideas con estilo y efectividad. Acabados de los planos y estructuras metálicas para añadir un toque de estilo a la imagen de la empresa.















Il trasferimento delle connessioni al piano lavoro è studiato e risolto per rispondere ad ogni necessità. Inoltre una vasta gamma di accessori permette di aiutare ad evolvere la postazione lavoro. The transfer of the connections to the work top is researched and solved in order to respond to every need. Furthermore, an extensive range of accessories helps the workstation to evolve.

L'acheminement des connexions au plan de travail est étudié et résolu pour répondre à tous les besoins. De plus, une vaste gamme d'accessoires permet de faire évoluer le poste de travail.

Die Übertragung der Anschlüsse auf die Arbeitsfläche wurde so ausgearbeitet und gelöst, dass sie jeden Anspruch erfüllt. Außerdem bietet eine umfangreiche Palette an Accessoires Unterstützung bei der Evolution des Arbeitsplatzes.

De overgang van de verbindingen naar het werkvlak is ontworpen en gerealiseerd om aan alle mogelijke vereisten te beantwoorden. Bovendien kan de werkplaats dank zij een wijd gamma toebehoren uitgebreid worden.

La transferencia de las conexiones al plano de trabajo se ha estudiado y solucionado para responder a cualquier demanda. Además, una amplia gama de accesorios permite ayudar la evolución del puesto de trabajo.



# Loopy

## SCRIVANIE - DESKS - BUREAUX - SCHREIBTISCHE - BUREAUS - ESCRITORIOS

180/200 x 100 x 72h

80/100/120/140/160/180/200 x 80 x 72h

140/160/180/200 x 124/164 x 72h

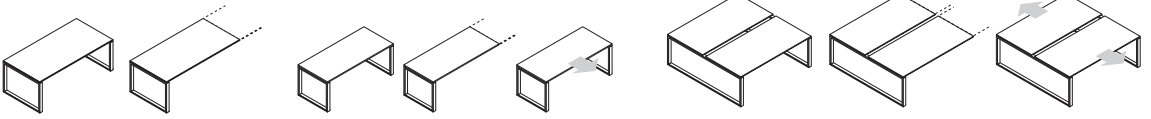

## SCRIVANIE PER AGGANCIAMENTO A MOBILI DI SERVIZIO - DESK FOR HOOKING TO THE STORAGE UNIT - BUREAU POUR FIXATION SUR MEUBLE DE SERVICE SCHREIBTISCH ZUM ANHÄNGEN AN SERVICE-MÖBEL - BUREAU VOOR VASTHAKING AAN DIENSTMODULE - ESCRITORIO PARA ENGANCHAMIENTO AL MUEBLE DE SERVICIO

180/200 x 100 x 72h

180/200 x 100 x 72h

136,5x62,2x56,7h

136,5x62,2x63h

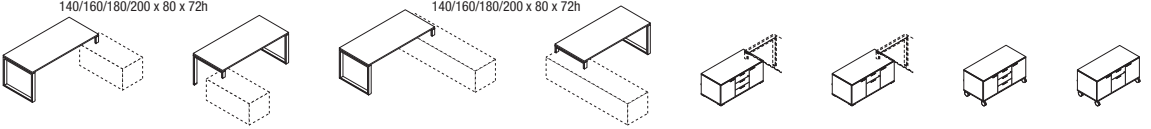

## ESEMPI DI COMPONIBILITA' UBI - UBI MODULARITY EXAMPLES - EXEMPLES MODULARITE UBI UBI BEISPIELE DER ANBAUMOGELICHKEITEN - UBI VOORBEELDEN VOOR AANBOUW - EJEMPLOS DE COMPOSICION UBI

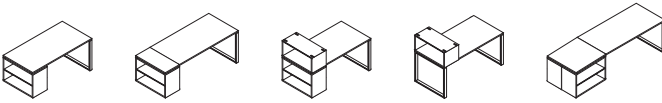

120 x 1,8 x 32h

140 x 1,8 x 32h

140 x 1,8 x 32h

65 x 0,6 x 32h

**BENCH - BENCH - BENCH - BENCH - BENCH - BENCH**

L. 80/100/120/140/160/180/200/240

55 x 44

55 x 44

80/100/120/140/160/180/200 x 44

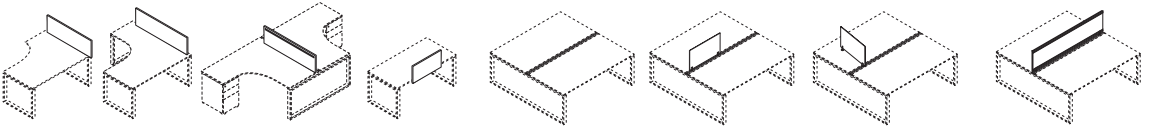

## TAVOLI RIUNIONE - MEETING TABLES - TABLES DE REUNION - KONFERENTZISCHE - KONFERENTTIETAFEL - MESAS REUNIONES

Ø80 x 72=109h

Ø118 x 72h  
Ø110 x 72h

124 x 124 x 72h

240 x 124 x 72h

280 x 100 x 72h

480 x 100 x 72h

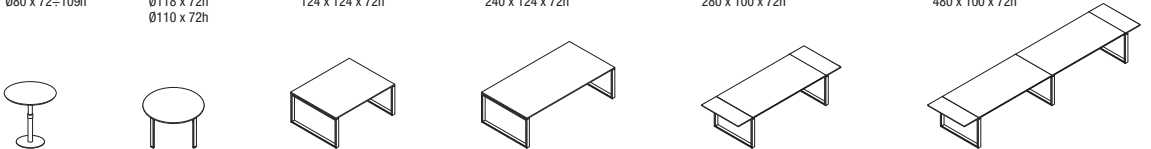

## CASSETTIERE METALLICHE - METAL PEDESTALS - CAISSONS METALLIQUES METALL CONTAINER - METALEN LADENBLOKKEN - CAJONERAS METALICAS

42 x 58,3 x 69,3h  
42 x 60 x 1,9h top

42 x 79 x 69,3h  
42 x 80 x 1,9h top

42 x 53,3 x 55,5h

## CASSETTIERE E MODULI DI SERVIZIO IN MELAMINICO - MELAMINE PEDESTALS AND SERVICE MODULES - CAISSONS ET ELEMENTS DE SERVICE EN MELAMINE - MELAMIN CONTAINER UND MULTIFUNKTIONSCONTAINER - MELAMINE LADENBLOKKEN EN SERVICEMODULEN - CAJONERAS Y ELEMENTOS DE SERVICIO MELAMINICO

42 x 56 x 59h

92 x 56 x 59h

103,6x46x72h

203,6x46x72h



## ARMADI H. 158 - CABINETS - ARMOIRES SCHRÄNKE - KASTEN ARMARIOS

L. 50

L. 100

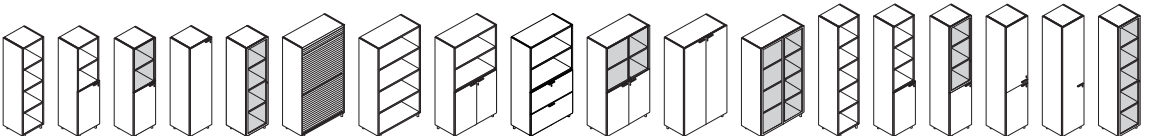

## ARMADI H. 197 - CABINETS - ARMOIRES SCHRÄNKE - KASTEN - ARMARIOS

L. 50

80/100/120/140/160/  
180/200 x 60 x 72h

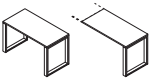

80/100/120/140/160/  
180 x 60 x 72h

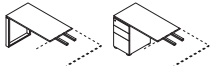

100/120/140/160/180/  
200 x 60 x 72h

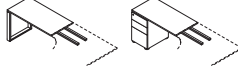

160/180 x 120 x 72h dx-sx



160 x 160 x 72h dx-sx

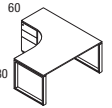

182x62,2x56,7h



227,5x62,2x56,7h

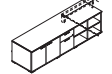
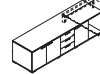
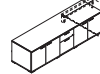

**ACCESSORI - ACCESSORIES - ACCESSOIRES - ZUBEHÖRE - ACCESSOIRES- ACCESORIOS**

45/65/85/125/145/  
165 x 1,8 x 30h

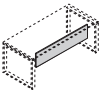

45/65/85/125/145/  
165 x 1 x 30h



60/80/100/120/140/160/180 x 1,8 x 32h

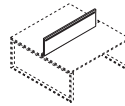

60/80/100 x 1,8 x 32h

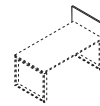

60/80 x 1,8 x 32h

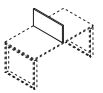

40 x 40

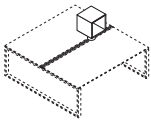

80 x 40

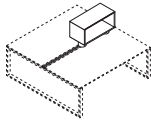

80 x 30

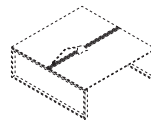
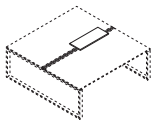
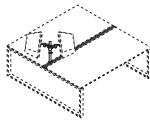

60/80/100 x 4 x 116h

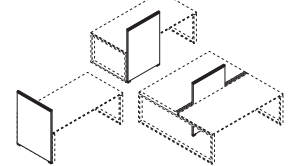

410 x 360 x 72h

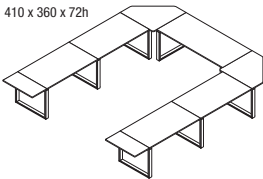

320 x 320 x 72h

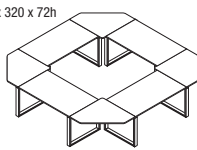

90(80) x 90(80) x 1,8h

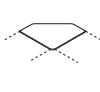

40 x 80 x 1,8h

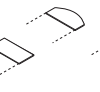

40 x 100 x 1,8h



40 x 124 x 1,8h

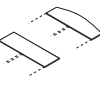

40 x 164 x 1,8h

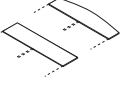

103,6x46x123h



203,6x46x123h

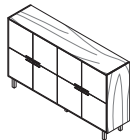

L. 50



L. 100

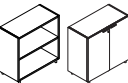

**ARMADI H. 81 - CABINETS - ARMOIRES -  
SCHRANKE - KASTEN - ARMARIOS**

L. 50



L. 100

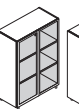
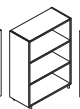

L. 100

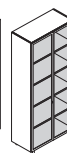
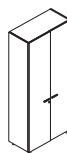
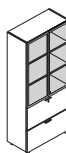
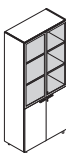
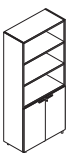
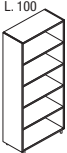

**TOP - TOP - TOP  
ABDECKPLATTE  
TOPBLAD**

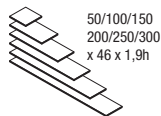

**ZOCOLI IN ALLUMINIO - ALUMINIUM  
PLINTHS - PLINTHES EN ALUMINIUM  
SÖCKEL AUS ALUMINIUM - PLINTEN  
IN ALUMINIUM**

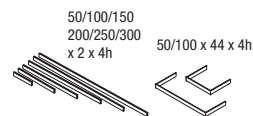

**FIANCHI DI CHIUSURA - CLOSING SIDES  
FLANCS DE FINITION - ABSCHLUSSFLANKEN  
ZUPANELEN**

1,9 x 46 x 82,8/159,6/  
198/236,5/278,9h

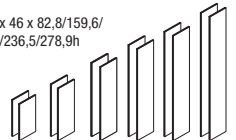

**PT** Mogano t. palissandro  
 Palisander Stained Mahogany  
 Acajou t. palissandre  
 Mahagonyholz  
 Palisander-Nachbildung  
 Mahoniehout  
 Palissander Gekleurd  
 Caoba p.palissandro

**CL** Ciliegio  
 Cherry  
 Cerisier  
 Kirschbaum  
 Kersenhout  
 Cerezo

**NC** Noce Canaletto  
 Canaletto Walnut  
 Canaletto Noyer  
 Canaletto Nußbaum  
 Notenhout Canaletto  
 Nogal Canaletto

**WE** Wengé  
 Wengé  
 Wengé  
 Wengé  
 Wengé  
 Wengé

**RN** Rovere Naturale  
 Oak  
 Eiche  
 Eikenhout  
 Rouvre  
 Roble Natural

**AC** Acero  
 Maple  
 Erable  
 Ahorndekor  
 Esdoornout  
 Arce

**GP** Grigio Perla  
 Pearl Grey  
 Gris Perle  
 Perlgrau  
 Parel Grijs  
 Gris Perla

**BL** Bianco  
 White  
 Blanc  
 Weiß  
 Wit  
 Blanco

**HK** Laminato Nero  
 Black Laminated  
 Lamifié Noir  
 Lamelliert Schwarz  
 Galamineerd Zwart  
 Laminado Negro

**HW** Laminato Bianco  
 White Laminated  
 Lamifié Blanc  
 Lamelliert Weiß  
 Galamineerd Wit  
 Laminado Blanco

## CRISTALLO - GLASS - VERRE GLAS - GLAS - VIDRIO

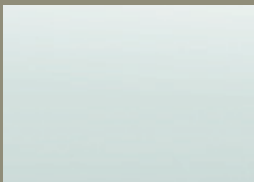

**CT** Vetrol temperato satinato  
 Tempered glass satin  
 Verre trempe satine  
 Temperiertes Glas mattier  
 Gehard glas gesatineerd  
 Vidrio templado satinado

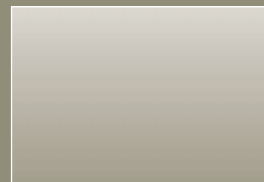

**CO** Vetrol temperato Tortora  
 Tortora tempered glass  
 Verre trempe Tortora  
 Tortora Temperiertes Glas  
 Gehard glas Tortora  
 Vidrio templado Tortora

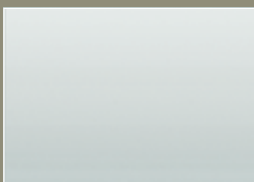

**CS** Vetrol Bisatinato  
 Glass frosted on both sides  
 Verre satiné sur les deux faces  
 Beidseitig satiniertes Glas  
 Tweezijdig gesatineerd glas  
 Vidrio bisatinado

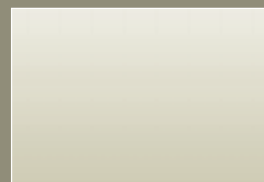

**CH** Vetrol temperato Nebbia  
 Nebbia tempered glass  
 Verre trempe Nebbia  
 Nebbia Temperiertes Glas  
 Gehard glas Nebbia  
 Vidrio templado Nebbia



**CN** Vetrol temperato nero  
 Black tempered glass  
 Noir verre trempe  
 Temperiertes Glas schwarz  
 Gehard glas zwart  
 Vidrio templado negro

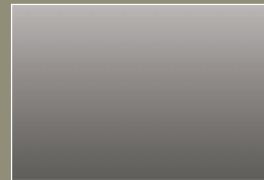

**CU** Vetrol temperato Titanio  
 Titanio tempered glass  
 Verre trempe Titanio  
 Titanio Temperiertes Glas  
 Gehard glas Titanio  
 Vidrio templado Titanio

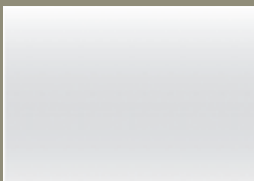

**CB** Vetrol temperato bianco  
 White tempered glass satin  
 Verre trempe blanc  
 Temperiertes Glas weiß  
 Gehard glas wit  
 Vidrio templado blanco

**LACCATI - LACQUERED - LAQUÈS  
LACKIERTES - GELAKT - LAQUEADO**

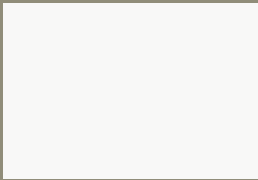

**LB** Laccato Bianco  
White Lacquered  
Laqué Blanc  
Weiß Lackiert  
Wit Gelakt  
Laqueado Blanco

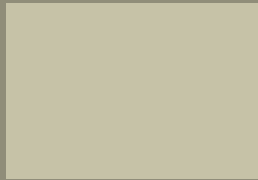

**L3** Laccato Nebbia  
Fog Lacquered  
Laqué Brouillard  
Nebel Lackiert  
Mist Lak  
Lacado Niebla



**L2** Laccato Tortora  
Tortora Lacquered  
Laqué Tortora  
Tortora Lackiert  
Tortora Lak  
Lacado Tortora



**L4** Laccato Titanio  
Titanio Lacquered  
Laqué Titanio  
Titanio Lackiert  
Titanio Lak  
Lacado Titanio

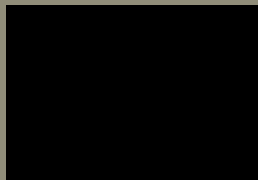

**LN** Laccato Nero  
Black Lacquered  
Laqué Noir  
Schwarzlackiert  
Zwart Gelakt  
Laqueado Negro

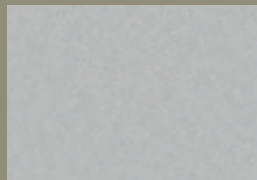

**LA** Laccato Alluminio  
Aluminium Lacquered  
Laqué Aluminium  
Aluminium Lackiert  
Aluminium Gelakt  
Laqueado Aluminio



**LQ** Laccato Tangerine  
Tangerine Lacquered  
Laqué Tangerine  
Tangerine Lackiert  
Tangerine Lak  
Lacado Tangerine



**LJ** Laccato Giallo Gold  
Giallo Gold Lacquered  
Laqué Giallo Gold  
Giallo Gold Lackiert  
Giallo Gold Lak  
Lacado Giallo Gold



**LF** Laccato Verde Natura  
Verde Natura Lacquered  
Laqué Verde Natura  
Verde Natura Lackiert  
Verde Natura Lak  
Lacado Verde Natura



**L5** Laccato Oceano  
Oceano Lacquered  
Laqué Oceano  
Oceano Lackiert  
Oceano Lak  
Lacado Oceano

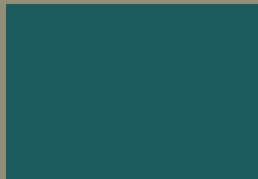

**LE** Laccato Deep Teal  
Deep Teal Lacquered  
Laqué Deep Teal  
Deep Teal Lackiert  
Deep Teal Lak  
Lacado Deep Teal



**LR** Laccato Rosso Bordeaux  
Bordeaux Lacquered  
Laqué Bordeaux  
Bordeaux Lackiert  
Bordeau Gelakt  
Laqueado Burdeos

**TESSUTO - FABRIC - TISSU  
STOFFE - STOF - TEJIDO**



**P9**



**P8**



**P6**

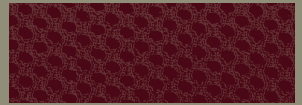

**P4**



**P7**



**P0**



# Glider System

Glider è un programma flessibile con spiccate caratteristiche di trasformazione dalle soluzioni Direzionali-Operative-Home Office, con possibilità di adattarsi alle esigenze del singolo o del lavoro di gruppo. Ampia gamma di finiture proposte: legno impiallacciato, melaminico, cristalli colorati e HPL.

Glider is a flexible program with important transformation characteristics from the Executive-Operative-Home Office solutions, with the possibility of adapting to the requirements of every individual or work group. A wide range of finishes are available: wood veneer, melamine, coloured glass and HPL.

Glider est un programme souple aux caractéristiques particulières de transformation à partir des solutions directionnelles-opérationnelles Home Office. Possibilité d'adaptation aux exigences individuelles ou du travail de groupe. Vaste gamme de finitions: bois aggloméré, melamine, verre coloris et HPL.

Glider ist ein flexibles Programm mit ausgeprägten Verwandlungsmöglichkeiten der Direktion-Operative-Home Office-Lösungen mit Anpassung an die Ansprüche von Einzelnen oder Arbeitsgruppen. Großes Sortiment der Ausführungen: Holzfurnier, Melamine, farbiges Kristallglas und HPL.

Glider is een flexibel program met een uitgesproken tendens naar de verandering van geboden oplossingen voor Directie- en Bureau-meubilair - Home Office dat de mogelijkheid tot aanpassing aan de eisen van het individu of van de hele groep biedt. Er is een ruime keur aan afwerkingen voorhanden: fineerhout, melamine, gekleurd kristalglas en HPL.

Glider es un programa flexible con marcadas características de transformación de las soluciones Direccionales-Operativas-Home Office, con posibilidad de adaptarse a las exigencias de cada individuo o del trabajo de grupo. Amplia gama de acabados propuestos: madera chapeada, melamina, cristal coloreado y HPL.

I posti di lavoro sono disponibili anche con le gambe metalliche cromate. Oltre ai piani delle scrivanie anche le ante degli armadi con telaio alluminio possono essere dotate di vetri colorati nelle varianti come da cartella colori.

The work stations are also available with chromed metal legs. Besides the desk tops, the cabinet doors with aluminium frames can also be assembled with coloured glass panels in the options offered by the colour chart.

Les postes de travail sont disponibles également avec les pieds métalliques chromés. Outre les plateaux des bureaux, les portes des armoires avec châssis en aluminium peuvent être réalisées elles-aussi en vitres colorées dans les versions indiquées dans le nuancier.

Die Arbeitsplätze sind auch mit verchromten Metallbeinen erhältlich. Außer den Schreibtischplatten sind auch die Türen der Aluminium-schränke mit farbigem Glas in den Schattierungen der Farbenkarte verfügbar.

De werkplekken zijn ook verkrijgbaar met verchromde metalen poten. Naast de bureaubladen kunnen ook de kastdeuren met aluminium frame worden voorzien van gekleurd glas in de varianten van de kleurenkaart.

Los puestos de trabajo están disponibles también con las patas metálicas cromadas. Además de los planos de los escritorios, también las puertas de los armarios con bastidor de aluminio se pueden equipar con vidrios colorados, en las variantes indicadas en la carpeta de los colores.













Glider è anche un sistema di portali condivisi opportunamente completati da una gamma di accessori e separazioni che esprimono sobria individualità.

Glider is also a system of shared workstations which is opportunely completed by a range of accessories and screens which express a sober individual character.

Glider est également un système de portails partagés équitablement, complétés par une gamme d'accessoires et de séparations qui expriment une individualité sobre.

Glider bedeutet auch ein aufgeteiltes Portalsystem, das durch eine entsprechende Auswahl von Zubehörteilen und Trennelementen eine individuelle Eleganz vermittelt.

Glider is tevens een systeem van gemeenschappelijk te benutten stellingen, dat door zijn gamma van toebehoor en scheidingselementen een sober eigen karakter uitdrukken.

Glider también es un sistema de portales compartidos, completados oportunamente con una gama de accesorios y de separaciones que expresan una sobria individualidad.











Posti di lavoro in linea, moltiplicabili all'infinito, personalizzati con i contenitori Ubi laccati, gli accessori, lampada e schermi, inseriti nella barra attrezzabile.

In-line workstations, they can be endlessly multiplied; they may be personalised with Ubi varnished containers, the accessories, table lamp and screens, inserted in a bar able to be equipped.

Postes de travail en ligne, à multiplier à l'infini, personnalisés par des armoires Ubi laquées, des accessoires, des lampes et des écrans, insérés sur la barre porte-accessoires.

Reihen-Arbeitsplätze, bis ins Unendliche multiplizierbar, individuell gestaltet mit den lackierten Behältern Ubi und den Accessoires, Lampen und Abschirmungen, die in die auszustattende Schiene eingefügt werden.

In-lijn werkplaatsen, oneindig uitbreidbaar, te verpersoonlijken met de gelakte Ubi-houders, het toebehoren, lamp en schermen, die op de uitrustbare staaf geïnstalleerd kunnen worden.

Puestos de trabajo en línea, que se pueden multiplicar al infinito, personalizables con los contenedores Ubi barnizados, los accesorios, la lámpara y las pantallas, introducidos en la barra que se puede equipar.

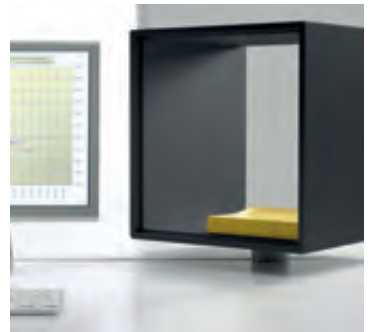





Non solo posti di lavoro operativi ma anche isole direzionali realizzate grazie alla flessibilità del sistema di travi telescopiche sottopiano e l'elegante accostamento di diverse tipologie di piani. Not only operative workstations but also executive areas created thanks to the flexibility of the telescopic beam system below the work tops and the elegant combination of various kinds of work tops. Ce ne sont pas seulement des postes de travail opérationnels, mais aussi des îles directionnelles réalisées grâce à la souplesse du système de poutre télescopiques situées sous le plan, et au rapprochement élégant entre diverses typologies de plans.

Nicht nur operative Arbeitsplätze sondern freistehende Direktionspositionen, die ihre Realisierung der Flexibilität des Teleskopträger-systems und der eleganten Zusammenstellung der unterschiedlichen Arbeitsflächen verdanken.

Men kan niet alleen gewone bureauplaatsen, maar ook alleenstaande directie- en conferentietafels creëren met het flexibele systeem van werkbladen op telescopische dwarsverbindingen combinaties van verschillende soorten werkvlakken realiseren.

No solamente puestos de trabajo operativos, sino también islas direccionales realizadas gracias a la flexibilidad del sistema de vigas telescópicas sub-piano y el elegante acercamiento de varios tipos de planos.



Due postazioni di lavoro completamente autonome, divise da contenitori Ubi attrezzati ed accessoriati montati sul podio con ruote, facile da spostare, divengono elementi d'ordine flessibile e dinamici.

Two completely autonomous workstations, divided by Ubi containers equipped and fitted with accessories mounted on the easy to move podium with castors, become elements of a flexible and dynamic type.

Deux postes de travail entièrement autonomes, séparés par des armoires Ubi équipées et accessorisées, montées sur un podium avec roulettes facile à déplacer, qui deviennent des éléments de rangement flexibles et dynamiques.



Zwei komplett autonome Arbeitsplätze, getrennt durch ausgestattete und mit Accessoires versehene Behälter Ubi, die auf ein einfach zu verlagerndes Podest auf Rädern montiert sind und zu flexiblen und dynamischen Elementen der Ordnung werden.

Twee volledig autonome werkplaatsen, verdeeld door Ubi-houders met toebehoren op een basisstructuur met wieltjes, gemakkelijk verplaatsbaar, worden flexibele en dynamische ordeningselementen.

Dos puestos de trabajo completamente autónomos, divididos por contenedores Ubi equipados y con accesorios, montados en la base con ruedas fácil de desplazar, se convierten en elementos de orden flexibles y dinámicos.













Particolari del piedino registrabile, della ruota opzionale e del sistema di elevazione in altezza delle gambe metalliche.  
Detail of the adjustable foot, of the optional caster-wheel and of the metallic legs' height-adjustment system.  
Détails du pied réglable, de la roulette en option et du système d'élévation en hauteur des pieds métalliques.  
Detail des einstellbaren Stützfüßen, der optionalen Rollen und des Höhenverstellmechanismus der Metallbeine.  
Details van het verstelbare voetje, van het optionele wiel en van het liftstelsel van de metalen poten.  
Detalles del pie ajustable, de la rueda opcional y del sistema de elevación en altura de las patas metálicas.





Glider System \_ 101

Sistema di convogliamento dei cavi elettrici ed informatici; spirale per la salita, panierino basculante per l'alloggiamento delle prese ed il deposito dei cavi, posizionabile tra le travi di supporto piano od al loro interno.

A transfer system of electrical and computer cables: spiral for the upward version, an inclining basket which holds plugs and cables, which can be positioned between the beams that support the work top or inside.

Système d'acheminement des câbles électriques et informatiques. Spirale pour la montée, paniers basculants pour loger les prises et le dépôt des câbles. A positionner entre les poutres de support du plan, ou à l'intérieur.

.01.



Führungssystem der Strom- und Informatikkabel, Spirale zum Hochführen der Kabel, Schwingelement für die Aufnahme der Steckdosen und Lagerung der Kabel, das zwischen oder in den Trägern der Tischplatte untergebracht werden kann.

Geleidingssysteem voor elektrische en PC bedrading; spiraal voor het omhoogleiden, hangmandjes voor de stekkerdozen en het ophangen van de kabels, die tussen de steunbalken onder het werkvlak of in de steunbalken zelf plaats vinden.

Sistema de conducción de los cables eléctricos e informáticos: espiral para la subida, bandeja volcable para el alojamiento de las tomas de corriente y el depósito de los cables, que se puede posicionar entre las vigas de soporte del plano o en su interior.



.02.



.03.



.05.



.04.



.06.



Fuoriuscita dei cavi dal posto di lavoro realizzata con semplice tappo in abs o torretta oppure scatola di alimentazione a scomparsa.

The cables emerge onto the workstation from a simple ABS cover or a tower or concealed box.

Sortie des câbles depuis le poste de travail, réalisé par un simple bouchon ABS, une tourelle ou une boîte d'alimentation d'escamotage.

Austritt der Kabel am Arbeitsplatz ausgeführt als einfacher Deckel aus ABS oder Verteilerrohr oder versenkbarem Steckdosenbehälter.

De kabels komen op de arbeidsplaats uit met een eenvoudige abs dop, een verdeelzuil of inklapbare stekkerdoos.

Salida de los cables del puesto de trabajo realizada con simple tapón de abs o torre, o bien caja de alimentación retráctil.

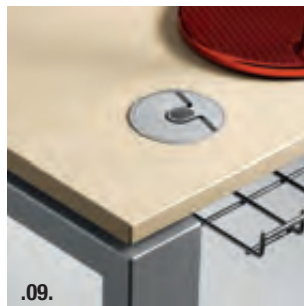





.13.



.16.



.14.

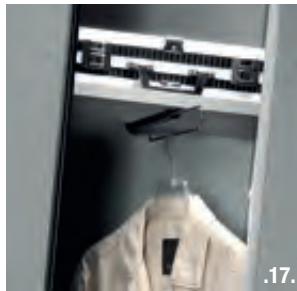

.17.



.15.



.18.

Particolari del sistema di archiviazione e di attrezzabilità degli armadi e dei moduli di servizio. Per pesi elevati è consigliato l'utilizzo dei ripiani metallici attrezzati a porta cartelle sospese. Nei contenitori da 50 cm. può essere alloggiato il frigorifero.

Details of the storage system and fitting-out of the cabinets and service modules. For heavy weights we recommend the use of steel shelves predisposed for hanging files. A fridge can be inserted into the 50cm containers.

Détails du système d'archivage et d'aménagements des armoires et des modules de service. Pour des poids importants, il est conseillé d'utiliser des tablettes métalliques équipées de porte-dossiers suspendus. Les accessoires de rangement de 50 cm peuvent contenir un réfrigérateur.

Besondere Archivations- und Aus-stattungssysteme der Schränke und der Serviceelemente. Für hohe Tag-lasten wird die Verwendung von Fachböden aus Metall für hängende Mappen empfohlen. In den 50 cm breiten Elementen kann der Kühlschrank untergebracht werden.

Archiefsysteem en van de inrichting van de kasten en de service elementen. Voor zware gewichten wordt het gebruik van de metalen tussenleggers aangeraden, die voor het ophangen van de archiefmappen zijn uitgerust. In de berguimtes van 50 cm. Kan een ijskast aangebracht worden.

Detalles del sistema de archivo y de equipamiento de los armarios y de los módulos de servicio. En caso de pesos elevados, se aconseja el uso de los planos metálicos equipados con porta-carpetas colgados. En los contenedores de 50 cm. se puede alojar una nevera.



# Glider System

## SCRIVANIE - DESKS - BUREAUX - SCHREIBTISCHE - BUREAUS- ESCRITORIOS

180/200 x 100 x 72h

80/100/120/140/160/180/200 x 80 x 72h

140/160/180/200 x 124/164 x 72h

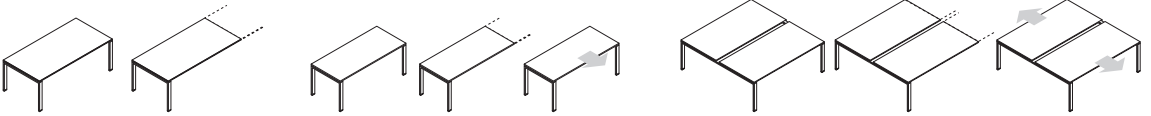

## SCRIVANIE PER AGGANCIAMENTO A MOBILI DI SERVIZIO - DESK FOR HOOKING TO THE STORAGE UNIT - BUREAU POUR FIXATION SUR MEUBLE DE SERVICE SCHREIBTISCHE ZUM ANHÄNGEN AN SERVICE-MÖBEL - BUREAU VOOR VASTHAKING AAN DIENSTMODULE - ESCRITORIO PARA ENGANCHAMIENTO AL MUEBLE DE SERVICIO

180/200 x 100 x 72h

180/200 x 100 x 72h

136,5x62,2x56,7h

136,5x62,2x63h

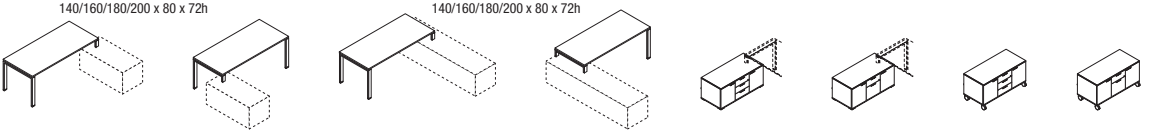

## ESEMPI DI COMPONIBILITA' UBI - UBI MODULARITY EXAMPLES - EXEMPLES MODULARITE UBI UBI BEISPIELE DER ANBAUMOGLICHKHEITEN - UBI VOORBEELDEN VOOR AANBOUW - EJEMPLOS DE COMPOSICION UBI

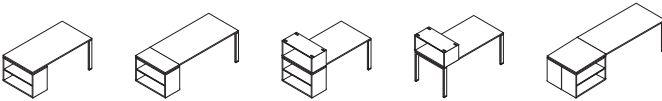

## BENCH - BENCH - BENCH - BENCH - BENCH - BENCH

120 x 1,8 x 32h

140 x 1,8 x 32h

140 x 1,8 x 32h

65 x 0,6 x 32h

L. 80/100/120/140/160/180/200/240

55 x 44

55 x 44

80/100/120/140/160/180/200 x 44

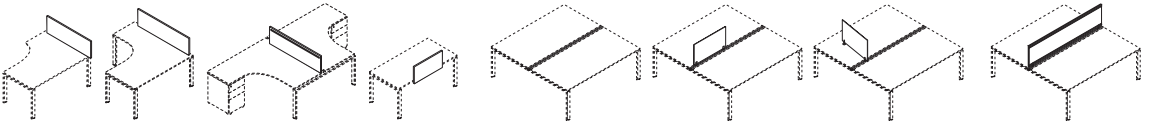

## TAVOLI RIUNIONE - MEETING TABLES - TABLES DE REUNION - KONFERENTZISCHE - KONFERENTIETAFEL - MESAS REUNIONES

Ø80 x 72=109h

Ø118 x 72h  
Ø110 x 72h

124 x 124 x 72h

240 x 124 x 72h

280 x 100 x 72h

480 x 100 x 72h

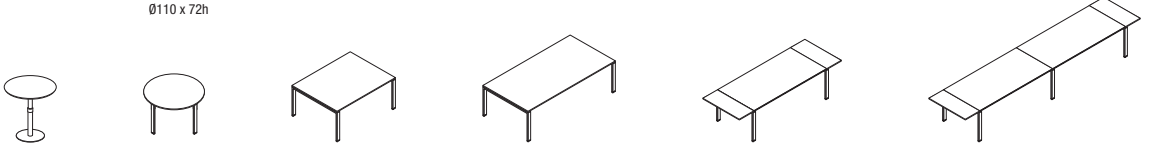

## CASSETTIERE METALLICHE - METAL PEDESTALS - CAISSONS METALLIQUES METALL CONTAINER - METALEN LADENBLOKKEN - CAJONERAS METALICAS

42 x 58,3 x 69,3h  
42 x 60 x 1,9h top

42 x 79 x 69,3h  
42 x 80 x 1,9h top

42 x 53,3 x 55,5h

## CASSETTIERE E MODULI DI SERVIZIO IN MELAMINICO - MELAMINE PEDESTALS AND SERVICE MODULES - CAISSONS ET ELEMENTS DE SERVICE EN MELAMINE - MELAMIN CONTAINER UND MULTIFUNKTIONSCONTAINER - MELAMINE LADENBLOKKEN EN SERVICEMODULEN - CAJONERAS Y ELEMENTOS DE SERVICIO MELAMINICO

42 x 56 x 59h

92 x 56 x 59h

103,6x46x72h

203,6x46x72h



## ARMADI H. 158 - CABINETS - ARMOIRES SCHRÄNKE - KASTEN ARMARIOS

L. 50

L. 100

## ARMADI H. 197 - CABINETS - ARMOIRES SCHRÄNKE - KASTEN - ARMARIOS

L. 50

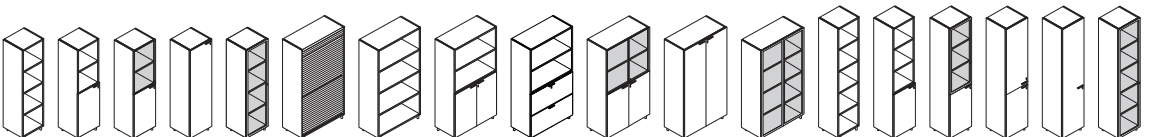

80/100/120/140/160/  
180/200 x 60 x 72h

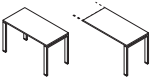

80/100/120/140/160/  
180 x 60 x 72h

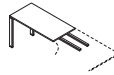

100/120/140/160/180/  
200 x 60 x 72h

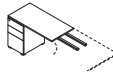

160/180 x 120 x 72h dx-sx

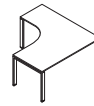

160 x 160 x 72h dx-sx

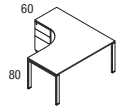

182x62,2x56,7h



227,5x62,2x56,7h

**ACCESSORI - ACCESSORIES - ACCESSOIRES - ZUBEHÖRE - ACCESSOIRES- ACCESORIOS**

45/65/85/125/145/  
165 x 1,8 x 30h

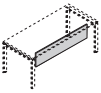

45/65/85/125/145/  
165 x 1 x 30h

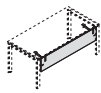

60/80/100/120/140/160/180 x 1,8 x 32h

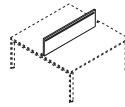

60/80/100 x 1,8 x 32h

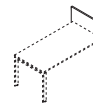

60/80 x 1,8 x 32h

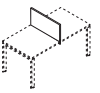

40 x 40

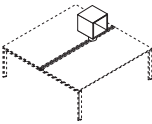

80 x 40

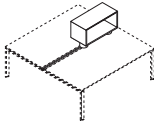

80 x 30

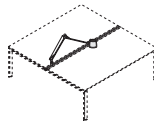
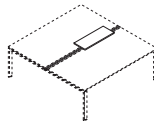
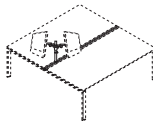

60/80/100 x 4 x 116h

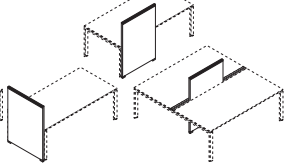

410 x 360 x 72h

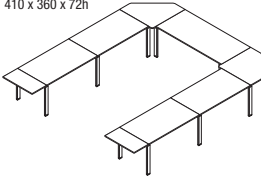

320 x 320 x 72h

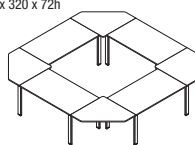

90(80) x 90(80) x 1,8h

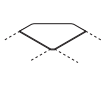

40 x 80 x 1,8h

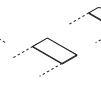

40 x 100 x 1,8h

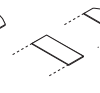

40 x 124 x 1,8h

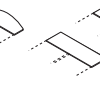

40 x 164 x 1,8h

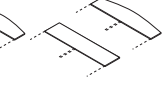

**ARMADI H. 81 - CABINETS - ARMOIRES -  
SCHRANKE - KASTEN - ARMARIOS**

103,6x46x123h



203,6x46x123h

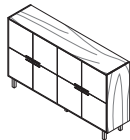

L. 50



L. 100

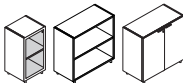

**ARMADI H. 120 - CABINETS - ARMOIRES -  
SCHRANKE - KASTEN - ARMARIOS**

L. 50



L. 100

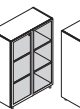
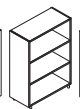

L. 100

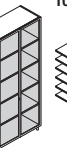
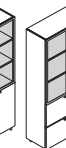
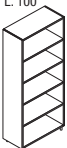

**TOP - TOP - TOP  
ABDECKPLATTE  
TOPBLAD**

50/100/150  
200/250/300  
x 46 x 1,9h

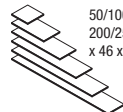

**ZOCCOLI IN ALLUMINIO - ALUMINIUM  
PLINTHS - PLINTHES EN ALUMINIUM  
SÖCKEL AUS ALUMINIUM - PLINTEN  
IN ALUMINIUM**

50/100/150  
200/250/300  
x 2 x 4h

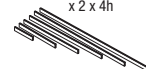

50/100 x 44 x 4h



**FIANCHI DI CHIUSURA - CLOSING SIDES  
FLANCS DE FINITION - ABSCHLUSSFLANKEN  
ZUPANELEN**

1,9 x 46 x 82,8/159,6/  
198/236,5/278,9h

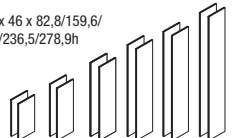

# Glider System

**PT** Mogano t. palissandro  
Palisander Stained Mahogany  
Acajou t. palissandre  
Mahagonyholz  
Palisander-Nachbildung  
Mahoniehout  
Palissander Gekleurd  
Caoba p.palissandro

**CL** Ciliegio  
Cherry  
Cerisier  
Kirschbaum  
Kersenhout  
Cerezo

**NC** Noce Canaletto  
Canaletto Walnut  
Canaletto Noyer  
Canaletto Nußbaum  
Notenhout Canaletto  
Nogal Canaletto

**WE** Wengé  
Wengé  
Wengé  
Wengé  
Wengé  
Wengé

**RN** Rovere Naturale  
Oak  
Eiche  
Eikenhout  
Rouvre  
Roble Natural

**AC** Acero  
Maple  
Erable  
Ahorndekor  
Esdoornout  
Arce

**GP** Grigio Perla  
Pearl Grey  
Gris Perle  
Perlgrau  
Parel Grijs  
Gris Perla

**BL** Bianco  
White  
Blanc  
Weiß  
Wit  
Blanco

**HK** Laminato Nero  
Black Laminated  
Lamifié Noir  
Lamelliert Schwarz  
Galamineerd Zwart  
Laminado Negro

**HW** Laminato Bianco  
White Laminated  
Lamifié Blanc  
Lamelliert Weiß  
Galamineerd Wit  
Laminado Blanco

## CRISTALLO - GLASS - VERRE GLAS - GLAS - VIDRIO

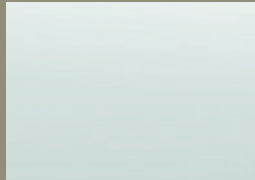

**CT** Vetrol temperato satinato  
Tempered glass satin  
Verre trempe satine  
Temperiertes Glas mattier  
Gehard glas gesatineerd  
Vidrio templado satinado



**CO** Vetrol temperato Tortora  
Tortora tempered glass  
Verre trempe Tortora  
Tortora Temperiertes Glas  
Gehard glas Tortora  
Vidrio templado Tortora

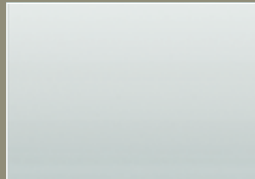

**CS** Vetrol Bisatinato  
Glass frosted on both sides  
Verre satiné sur les deux faces  
Beidseitig satiniertes Glas  
Tweezijdig gesatineerd glas  
Vidrio bisatinado



**CH** Vetrol temperato Nebbia  
Nebbia tempered glass  
Verre trempe Nebbia  
Nebbia Temperiertes Glas  
Gehard glas Nebbia  
Vidrio templado Nebbia



**CN** Vetrol temperato nero  
Black tempered glass  
Noir verre trempe  
Temperiertes Glas schwarz  
Gehard glas zwart  
Vidrio templado negro

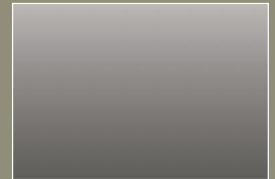

**CU** Vetrol temperato Titanio  
Titanio tempered glass  
Verre trempe Titanio  
Titanio Temperiertes Glas  
Gehard glas Titanio  
Vidrio templado Titanio

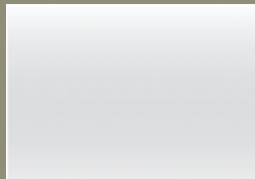

**CB** Vetrol temperato bianco  
White tempered glass satin  
Verre trempe blanc  
Temperiertes Glas weiß  
Gehard glas wit  
Vidrio templado blanco

**LACCATI - LACQUERED - LAQUÈS  
LACKIERTES - GELAKT - LAQUEADO**

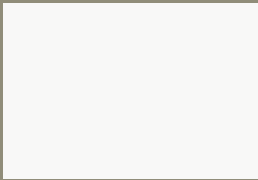

**LB** Laccato Bianco  
White Lacquered  
Laqué Blanc  
Weiß Lackiert  
Wit Gelakt  
Laqueado Blanco

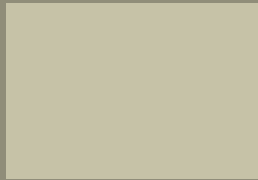

**L3** Laccato Nebbia  
Fog Lacquered  
Laqué Brouillard  
Nebel Lackiert  
Mist Lak  
Lacado Niebla



**L2** Laccato Tortora  
Tortora Lacquered  
Laqué Tortora  
Tortora Lackiert  
Tortora Lak  
Lacado Tortora



**L4** Laccato Titanio  
Titanio Lacquered  
Laqué Titanio  
Titanio Lackiert  
Titanio Lak  
Lacado Titanio



**LN** Laccato Nero  
Black Lacquered  
Laqué Noir  
Schwarzlackiert  
Zwart Gelakt  
Laqueado Negro

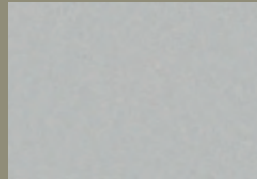

**LA** Laccato Alluminio  
Aluminium Lacquered  
Laqué Aluminium  
Aluminium Lackiert  
Aluminium Gelakt  
Laqueado Alluminio



**LQ** Laccato Tangerine  
Tangerine Lacquered  
Laqué Tangerine  
Tangerine Lackiert  
Tangerine Lak  
Lacado Tangerine



**LJ** Laccato Giallo Gold  
Giallo Gold Lacquered  
Laqué Giallo Gold  
Giallo Gold Lackiert  
Giallo Gold Lak  
Lacado Giallo Gold



**LF** Laccato Verde Natura  
Verde Natura Lacquered  
Laqué Verde Natura  
Verde Natura Lackiert  
Verde Natura Lak  
Lacado Verde Natura



**L5** Laccato Oceano  
Oceano Lacquered  
Laqué Oceano  
Oceano Lackiert  
Oceano Lak  
Lacado Oceano

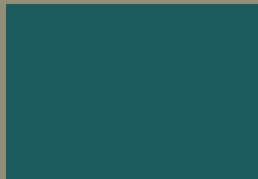

**LE** Laccato Deep Teal  
Deep Teal Lacquered  
Laqué Deep Teal  
Deep Teal Lackiert  
Deep Teal Lak  
Lacado Deep Teal



**LR** Laccato Rosso Bordeaux  
Bordeaux Lacquered  
Laqué Bordeaux  
Bordeaux Lackiert  
Bordeau Gelakt  
Laqueado Burdeos

**TESSUTO - FABRIC - TISSU  
STOFFE - STOF - TEJIDO**



**P9**



**P8**



**P6**

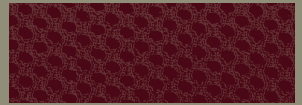

**P4**



**P7**



**P0**



# Ubi Evo

UBI EVO è un'ulteriore espressione della ricerca, alla scoperta di sempre più nuove soluzioni. Una scelta anticonvenzionale e allo stesso tempo di forte attualità, per creare nuove soluzioni per tutti gli ambienti lavoro: dalle postazioni operative, al contenimento, alla direzione e all'attesa.

UBI EVO is a yet another expression of our research, always seeking increasingly innovative solutions. An unconventional and at the same time strongly topical choice to create new solutions for all work environments: from operative workstations, to containment systems, for management and waiting rooms.

UBI EVO est une autre expression de la recherche, à la découverte de solutions toujours plus inédites. C'est un choix à la fois anti-conventionnel et très actuel, pour créer de nouvelles solutions pour toutes les ambiances de travail : des postes opérationnels aux systèmes de rangement, de la direction aux salles d'attente.

UBI EVO ist eine weitere Ausdrucksweise der Suche nach immer neuen Lösungen und ihrer Entdeckung. Eine antikonventionelle und gleichzeitig von starker Aktualität geprägte Wahl, um neue Lösungen für alle Arbeitsumgebungen zu schaffen: von den operativen Arbeitsplätzen über Behältersysteme bis hin zur Direktionsebene und zum Wartebereich.

UBI EVO is een verdere uitdrukking van het zoeken naar steeds nieuwe oplossingen. Een anti-conventionele keuze die tegelijkertijd sterk actueel is, om nieuwe oplossingen te creëren voor alle werkomgevingen: van de werkplekken, tot de opbergsystemen, het Directiemeubilair en de wachtzaal.

UBI EVO es una ulterior expresión de la investigación, en la búsqueda de soluciones siempre más nuevas. Una elección anticonvencional y al mismo tiempo de fuerte actualidad, para crear nuevas soluciones para todos los ambientes de trabajo: desde los puestos operativos a los sistemas de contención, hasta la dirección y a la espera.







Il sistema di contenimento estende il concetto di modularità per divenire base del piano di lavoro. Le soluzioni con gambe o con piedini si integrano con le scrivanie Take-Off, Glider e Loopy.

The containment system extends the modularity concept, becoming a base for the work top. The models designed with small legs or feet combine with the Take-Off, Glider and Loopy desks.

Le système de rangement élargit son concept de modularité et devient une base du plan de travail. Les solutions avec les piètements ou les pieds s'intègrent aux bureaux Take-Off, Glider et Loopy.



Das Behältersystem dehnt das Konzept der Modularität aus, um zum Untergestell der Arbeitsplatte zu werden. Die Lösungen mit Stützbeinen oder –füßen bilden eine Einheit mit den Schreibtischen Take-Off, Glider und Loopy.

Het opbergstelsel breidt het concept van de modulariteit uit en wordt de basis van het werkvlak. De oplossingen met pootjes of steunvoeten zijn geïntegreerd in de schrijftafels Take-Off, Glider en Loopy.

El sistema de contención amplía el concepto de estructura modular, para convertirse en la base del plano de trabajo. Las soluciones con patas o con pies se integran con los escritorios Take-Off, Glider y Loopy.











## M10

In alternativa alla tradizionale scrivania si possono creare postazioni singole o condivise di varie larghezze in appoggio ai contenitori M10, con ante scorrevoli e con vano tecnico. Lo spazio può essere organizzato e suddiviso inserendo diverse tipologie di accessori.

As an alternative to the traditional desk, self-standing or shared workstations can be created, of various widths, supporting M10 containers with sliding doors. The available space can be organised and subdivided by inserting different types of accessories.

Des postes individuels ou partagés, de différentes largeurs, posés sur les meubles de rangement M10 aux portes coulissantes, peuvent être créés en alternative au bureau traditionnel. L'espace peut être organisé et partagé en insérant différentes typologies d'accessoires.





Alternativ zum traditionellen Schreibtisch können einzelne oder geteilte Arbeitsplätze verschiedener Breiten kreiert werden, die auf den Behältern M10 mit Schiebetüren aufliegen. Der Raum kann durch Eingliederung verschiedener Typologien von Zubehör organisiert und unterteilt werden. Als alternatief voor de traditionele schrijftafel kan men enkele of gemeenschappelijke werkplaatsen creëren met verschillende breedtes ter ondersteuning van de bergruimte M10, met glijdeurtjes. De ruimte kan georganiseerd en onderverdeeld worden met verschillende soorten toebehoren. Como alternativa al escritorio tradicional es posible la creación de puestos individuales o compartidos de varias anchuras, apoyados en los contenedores M10, con puertas corredizas. El espacio puede organizarse y dividirse introduciendo varios tipos de accesorios.



M10





M10





**UBI BASE**  
80 x 40 x 69,1 h

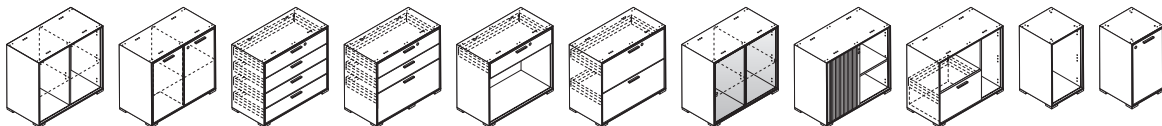

39,8 x 40 x 69,1 h

**UBI**  
80 x 40 x 39,8 h

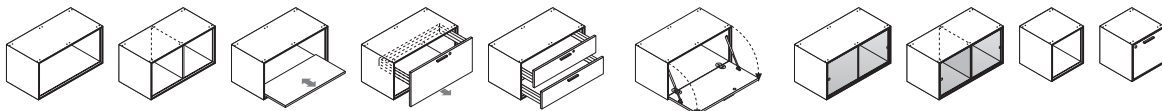

39,8 x 40 x 39,8 h

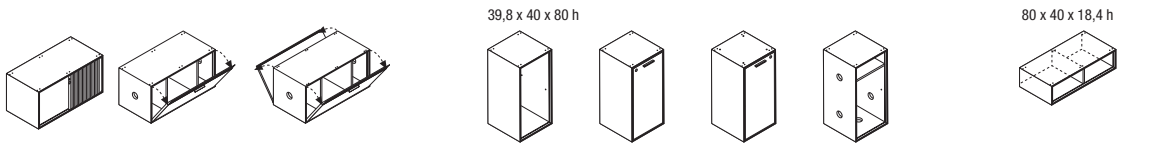

39,8 x 40 x 80 h

80 x 40 x 18,4 h

**UBI TOP**

**TOP A LATO SCRIVANIA E AD USO ARMADIO**  
**TOP ON THE DESK SIDE AND FOR FILING CABINET USE**  
**TOP AU CÔTÉ BUREAU ET À EMPLOYER COMME ARMOIRE**  
**ABDECKPLATTE SEITLICH DES SCHREIBTISCHES UND BASISBEHÄLTER UBI ALS**  
**SCHRANK VERWENDET**  
**TOP AAN DE ZIJKANT VAN HET BUREAU EN VOOR UBI BASIS TE GEBRUIKEN ALS KAST**  
**PLANO SUPERIOR AL LADO DEL ESCRITORIO Y A USO ARMARIO**

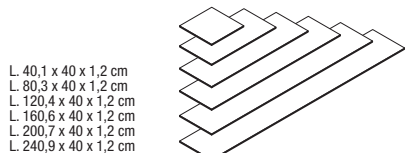

L. 40,1 x 40 x 1,2 cm  
L. 80,3 x 40 x 1,2 cm  
L. 120,4 x 40 x 1,2 cm  
L. 160,6 x 40 x 1,2 cm  
L. 200,7 x 40 x 1,2 cm  
L. 240,9 x 40 x 1,2 cm

80 x 80 x 1,8 h

40 x 80 x 1,8 h

40 x 80 x 1,8 h

40 x 40 x 1,8 h

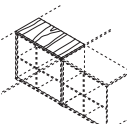
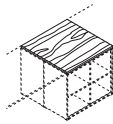

I top sono obbligatori - The tops are compulsory - Les tops sont obligatoires - Die Tops sind obligatorisch - De tops zijn verplicht - La partes superiores son obligatorias

**UBI PODIO**

**PODIO**  
**PIEDINI**  
**FEET**  
**PIEDS**  
**FUSSEN**  
**VOETJES**  
**PIES**

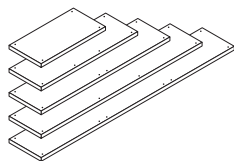

L. 80,3 x 40 x 5 h  
L. 120,4 x 40 x 5 h  
L. 160,6 x 40 x 5 h  
L. 200,7 x 40 x 5 h  
L. 240,9 x 40 x 5 h

**PODIO**  
**RUOTE**  
**WHEELS**  
**ROULETTES**  
**ROLLEN**  
**WIELEN**  
**RUEDAS**

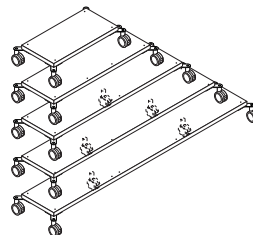

L. 80,3 x 40 x 17,4 h  
L. 120,4 x 40 x 17,4 h  
L. 160,6 x 40 x 17,4 h  
L. 200,7 x 40 x 17,4 h  
L. 240,9 x 40 x 17,4 h

**PODIO PER UBI CON BASI**  
**PODIO FOR UBI WITH BASES**  
**PODIO POUR UBI AVEC BASES**  
**PODIUM FÜR UBI MIT BASIS**  
**PODIUM VOOR UBI, MET 2 ZUILEN MET BASIS**  
**PODIO DE UBI CON BASES**

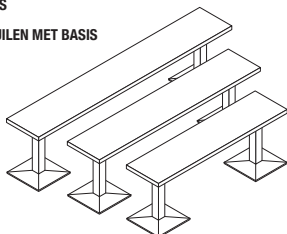

L. 160,6 x 40 x 61 h  
L. 200,7 x 40 x 61 h  
L. 240,9 x 40 x 61 h

**PODIO IN ALLUMINIO PER UBI**  
**ALUMINIUM PODIO FOR UBI**  
**PODIO EN ALUMINIUM POUR UBI**  
**PODIUM AUS ALUMINIUM FÜR UBI**  
**ALUMINIUM PODIUM VOOR UBI**  
**PODIO DE UBI EN ALUMINIO**

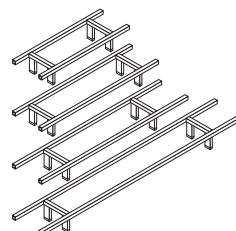

L. 120,1 x 40 x 21,6 h  
L. 160,3 x 40 x 21,6 h  
L. 200,4 x 40 x 21,6 h  
L. 240,6 x 40 x 21,6 h

ESEMPI DI COMPONENTABILITA' UBI EVO - UBI EVO MODULARITY EXAMPLES - EXEMPLES MODULARITE UBI EVO  
 UBI EVO BEISPIELE DER ANBAUMOGELICHKEITEN - UBI EVO VOORBEELDEN VOOR AANBOUW - EJEMPLOS DE COMPOSICION UBI EVO

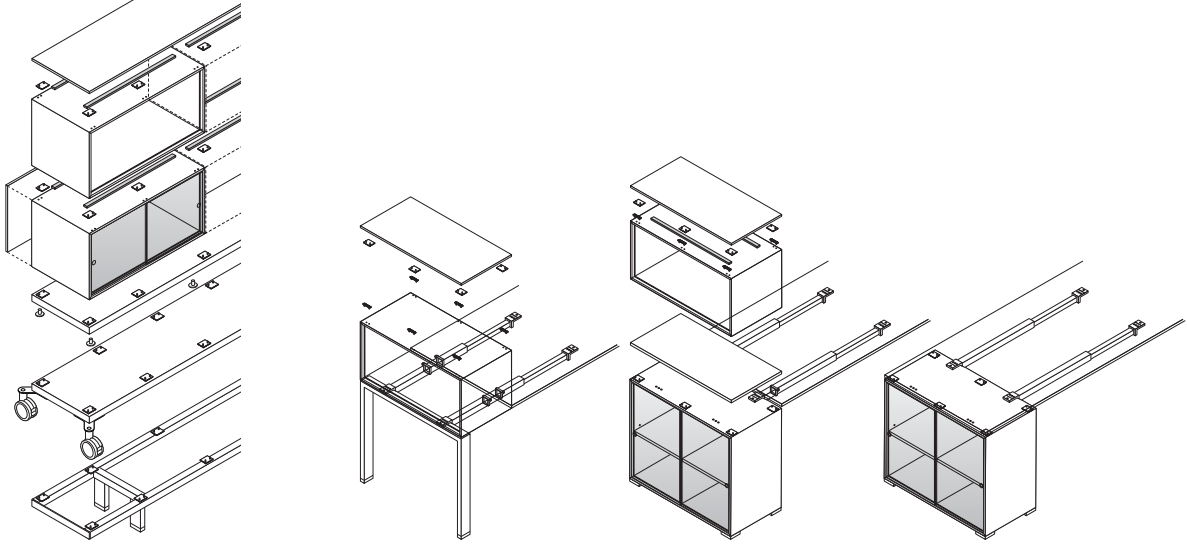

ESEMPI DI COMPONENTABILITA' PODIO - PODIO MODULARITY EXAMPLES - EXEMPLES MODULARITE PODIO  
 PODIO BEISPIELE DER ANBAUMOGELICHKEITEN - PODIO VOORBEELDEN VOOR AANBOUW - EJEMPLOS DE COMPOSICION PODIO

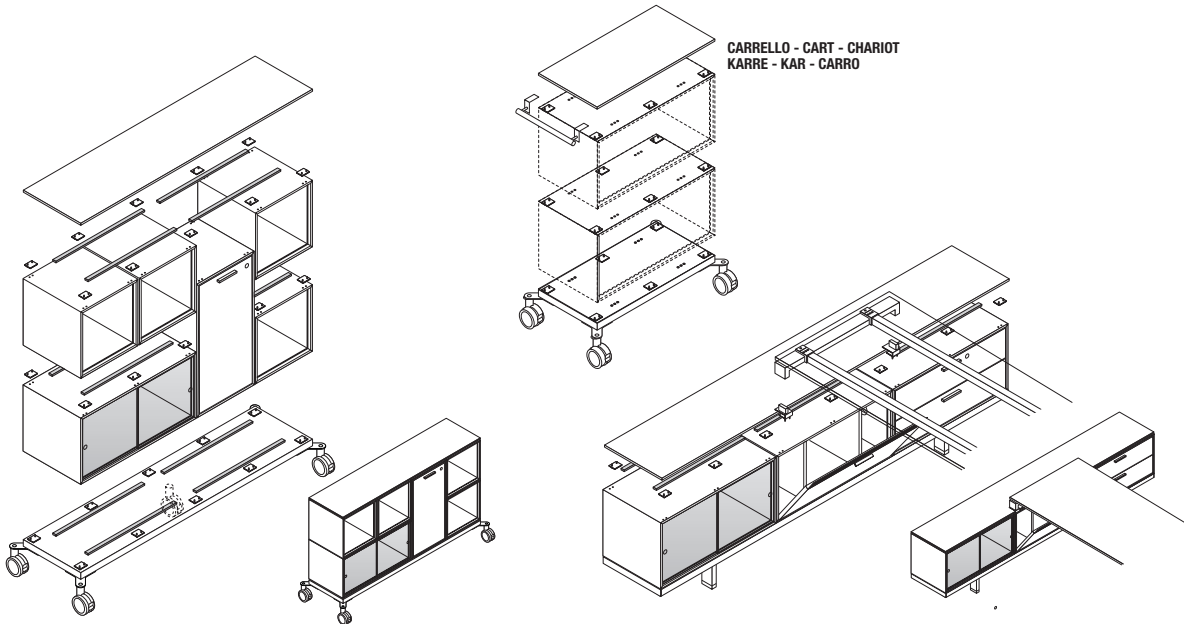

I top sono obbligatori - The tops are compulsory - Les tops sont obligatoires - Die Tops sind obligatorisch - De tops zijn verplicht - La partes superiores son obligatorias



# Ubi Evo - M10

## LACCATI - LACQUERED - LAQUÈS - LACKIERTES - GELAKT - LAQUEADO

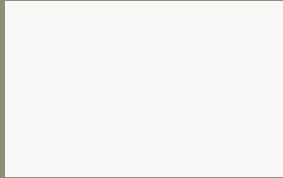

**LB** Laccato Bianco  
White Lacquered  
Laqué Blanc  
Weiß Lackiert  
Wit Gelakt  
Laqueado Blanco



**L3** Laccato Nebbia  
Fog Lacquered  
Laqué Brouillard  
Nebel Lackiert  
Mist Lak  
Lacado Niebla

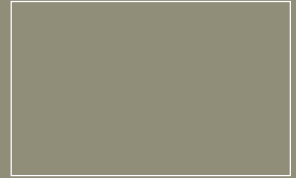

**L2** Laccato Tortora  
Tortora Lacquered  
Laqué Tortora  
Tortora Lackiert  
Tortora Lak  
Lacado Tortora



**L4** Laccato Titanio  
Titanio Lacquered  
Laqué Titanio  
Titanio Lackiert  
Titanio Lak  
Lacado Titanio

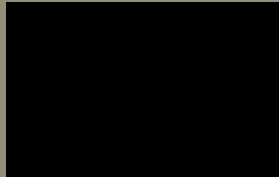

**LN** Laccato Nero  
Black Lacquered  
Laqué Noir  
Schwarzlackiert  
Zwart Gelakt  
Laqueado Negro

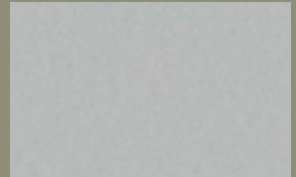

**LA** Laccato Alluminio  
Aluminium Lacquered  
Laqué Aluminium  
Aluminium Lackiert  
Aluminium Gelakt  
Laqueado Aluminio



**LQ** Laccato Tangerine  
Tangerine Lacquered  
Laqué Tangerine  
Tangerine Lackiert  
Tangerine Lak  
Lacado Tangerine



**LJ** Laccato Giallo Gold  
Giallo Gold Lacquered  
Laqué Giallo Gold  
Giallo Gold Lackiert  
Giallo Gold Lak  
Lacado Giallo Gold



**LF** Laccato Verde Natura  
Verde Natura Lacquered  
Laqué Verde Natura  
Verde Natura Lackiert  
Verde Natura Lak  
Lacado Verde Natura



**L5** Laccato Oceano  
Oceano Lacquered  
Laqué Oceano  
Oceano Lackiert  
Oceano Lak  
Lacado Oceano

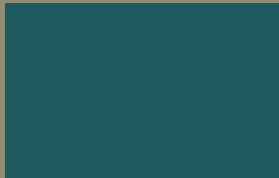

**LE** Laccato Deep Teal  
Deep Teal Lacquered  
Laqué Deep Teal  
Deep Teal Lackiert  
Deep Teal Lak  
Lacado Deep Teal



**LR** Laccato Rosso Bordeaux  
Bordeaux Lacquered  
Laqué Bordeaux  
Bordeaux Lackiert  
Bordeaux Gelakt  
Laqueado Burdeos



TESSUTO - FABRIC - TISSU  
STOFFE - STOF - TEJIDO



P9



P8



P6



P4



P7



P0

\* Solo per piani scrivania e top UBI spessore 18 mm.  
Only for desktops and 18 mm UBI top.  
Seulement pour plans bureau et top UBI 18 mm.  
Nur für Schreibtische und 18 mm UBI tops.  
Slechts voor Desktops en 18 mm UBI top.  
Solamente para la tapa de las mesas y parte superior 18 mm UBI.

MELAMINICI - MELAMINE - MELAMINE - MELAMIN - MELAMINE - MELAMINICO



WE Wengè  
Wengè  
Wengè  
Wengè  
Wengè  
Wengè



NC Noce Canaletto  
Canaletto walnut  
Noyer Canaletto  
Canaletto Nußbaum  
Notenhout Canaletto  
Nogal Canaletto

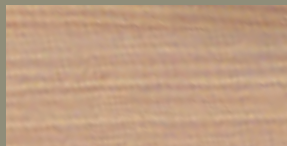

RN Rovere Naturale  
Oak  
Eiche  
Eikenhout  
Rouvre  
Roble Natural

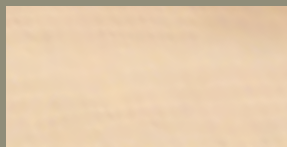

AC Acero  
Maple  
Erable  
Ahorndekor  
Esdoornout  
Arce

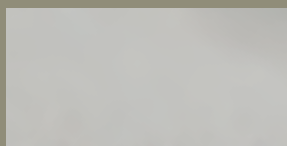

GP Grigio Perla  
Pearl Grey  
Gris Perle  
Perlgrau  
Parel Grijs  
Gris Perla

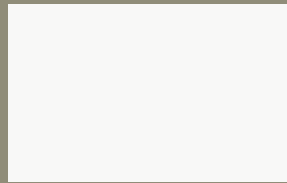

BL Bianco  
White  
Blanc  
Weiß  
Wit  
Blanco

METACRILATO-METHACRYLATE  
METHACRYLATE-METHACRYLAT  
METACRYLAAT-METACRILATO



MG



MV



MR



MZ



# Reception

Il programma "Reception" formato da elementi curvi o lineari aggregati tra di loro, permette molteplici configurazioni d'arredo in base alle esigenze di spazialità. L'accuratezza dei materiali impiegati e l'ampia possibilità di finiture disponibili conferisce un tono elevato di immagine.

The "Reception" program is made up of curved or linear elements which are connected between them and allows for several furnishing configurations according to space requirements. The careful use of the materials and the extensive range of finishes available provides an elegant image.

Le programme "Réception" est formé d'éléments courbes ou linéaires assemblés, et permet de nombreuses configurations d'ameublement, suivant les exigences de volumes.

Le soin dans les matériaux employés et les vastes possibilités de finitions disponibles donnent un ton haut de gamme à l'image.

Das Rezeptionsprogramm, das aus geschwungenen oder geradlinigen Elementen besteht, ermöglicht eine vielfältige Einrichtungsgestaltung, die den räumlichen Gegebenheiten gerecht wird. Die sorgfältige Auswahl der Materialien und das umfassende Sortiment der verfügbaren Ausführungen in furniertem sorgt für ein hohes Image.

De gebogen en rechte lijnen van de elementen, die gezamenlijk het "Receptie" uitmaken maken talloze variaties in de inrichting mogelijk, naargelang de ter beschikking staande ruimte. De nauwgezette materiaal-verwerking en de ruime keuzemogelijkheden voor de afwerkingen verlenen dit program een verheven aanblik.

El programa "Reception" formado por elementos curvos o lineales unidos entre ellos, permite muchas configuraciones de decoración, en función de las demandas de espacio. La calidad de los materiales utilizados y la amplia posibilidad de acabados disponibles confiere un tono elevado de imagen.























# Reception

Elemento caratterizzante è il piano ribassato, per permettere l'agevole accesso ai portatori di handicap.

The main element is the lowered top which allows for easy access for the disabled.

L'élément caractérisant est le plan abaissé, qui facilite l'accès aux porteurs de handicap.

Die niedrigere Arbeitsfläche stellt das charakterisierende Element dar, welches den Zugang für Behinderte erleichtert.

Het karakteristieke element is het verlaagde werkvlak, wat de benadering door lichamelijk gehandicapte personen vergemakkelijkt.

Un elemento característico es el plano rebajado, para permitir un fácil acceso a los discapacitados.

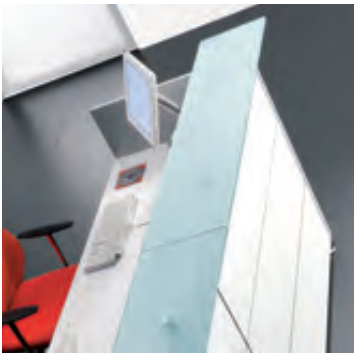

**RECEPTION - RECEPTION - RECEPTION - ACCUEILS - RECEPTE - RECEPCIÓN**

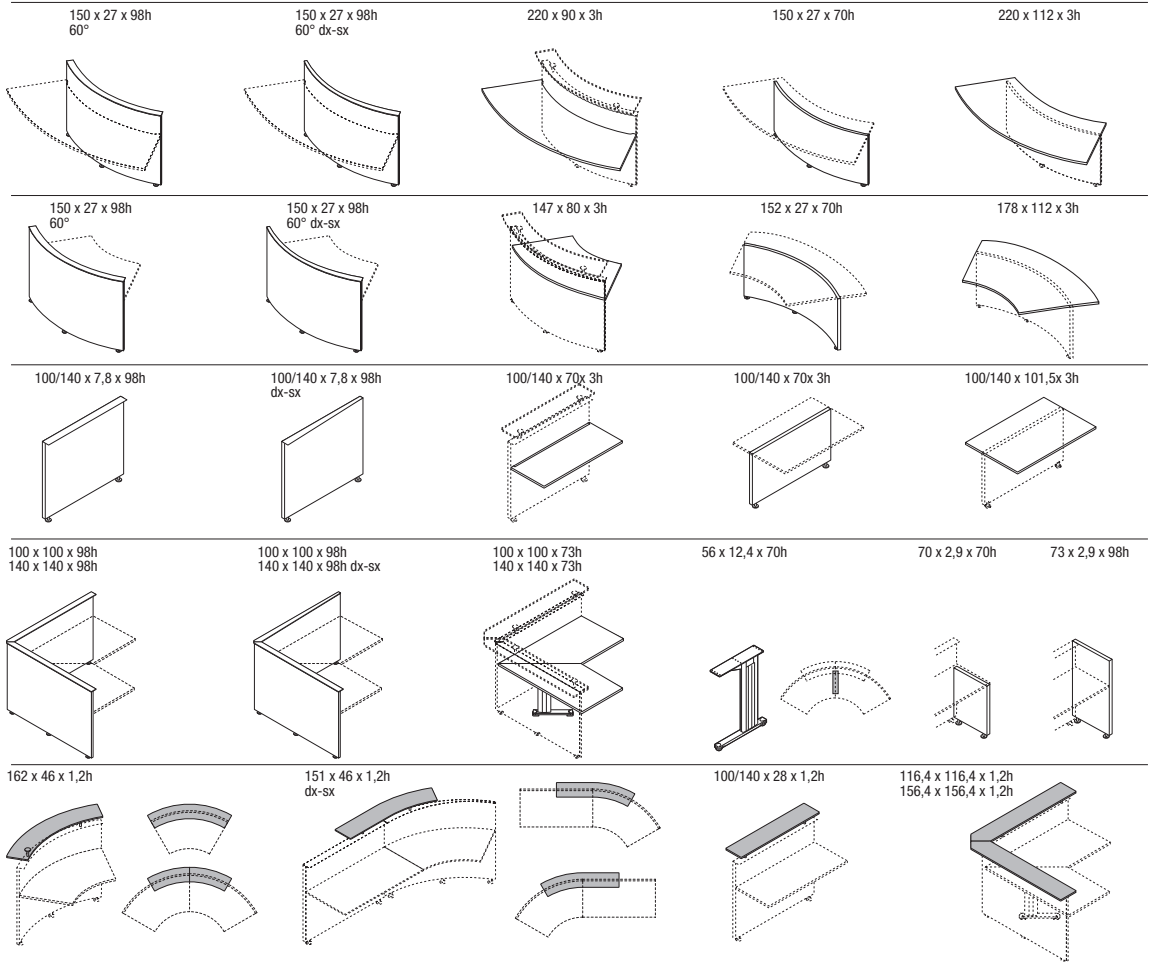

**ESEMPLI DI COMPONIBILITA' - MODULARITY EXAMPLES - EXEMPLES MODULARITE  
BEISPIELE DER ANBAUMÖGLICHKEITEN - VOORBEELDEN VOOR AANBOUW - EJEMPLOS DE COMPOSICIÓN**

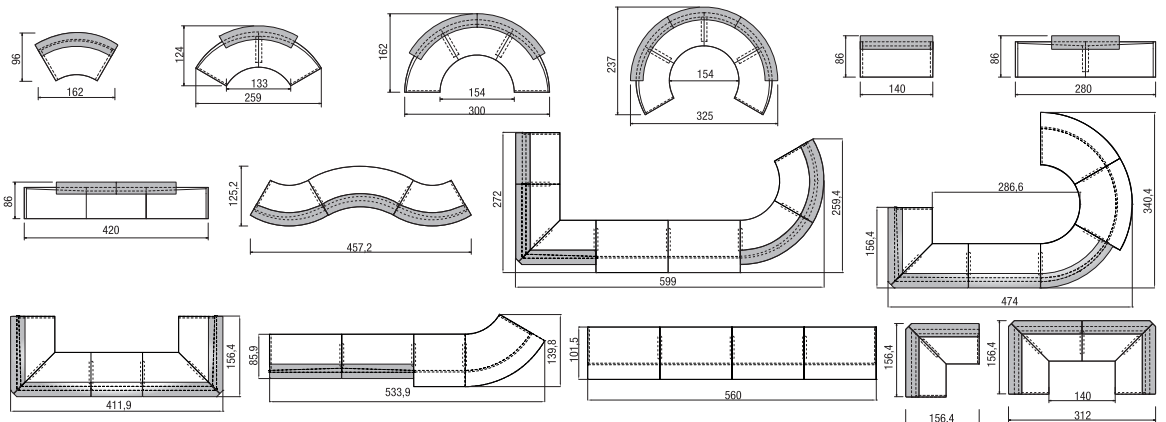

# Reception

PIANI DI LAVORO E GAMBE TERMINALI  
 WORK TOPS AND END LEGS  
 PLATEAUX DE TRAVAIL ET PIEDS TERMINALS  
 ARBEITSPLETTEN UND END BEIN  
 WERKBLADEN EN EIND Poot  
 PLANOS DE TRABAJO Y PATAS TERMINALES

## WE

Wengé  
 Wengé  
 Wengé  
 Wengé  
 Wengé



## NC

Noce Canaletto  
 Canaletto walnut  
 Noyer Canaletto  
 Canaletto Nußbaum  
 Notenhou Canaletto  
 Nogal Canaletto



## RN

Rovere Naturale  
 Natural Oak  
 Chene Naturel  
 Eiche natur  
 Natuurlijk Eikenhout  
 Roble natural



## BL

Bianco  
 White  
 Blanc  
 Weiß  
 Wit  
 Blanco



FRONTALI LATO INTERNO  
 FRONTS INNER SIDE  
 FAÇADES CÔTÉ INTÉRIEURE  
 FRONTBLEDEN INNERE VORDERSEITE  
 FRONTSTUKKEN INNERLIJKE VOORZIJDE  
 FRONTALES INTERIOR

## AM

Laminato Millerighe  
 Millerighe laminated  
 Lamifié Millerighre  
 Lamelliert Millerighe  
 Galamineerd Millerighe  
 Laminado Mirrayas



FRONTALI E FIANCHI DI CHIUSURA  
 FRONTS AND CLOSING SIDES  
 FAÇADES ET FLANGS DE FERMETURE  
 FRONTBLEDEN UND ABSCHLUSSFLANKEN  
 FRONTSTUKKEN EN ZISPANELEN  
 FRONTALES Y COSTADOS DE CIERRE

## WE

Wengé  
 Wengé  
 Wengé  
 Wengé  
 Wengé  
 Wengé



## QS

Cuoio Sabbia  
 Sand Hide  
 Cuir Sable  
 Hartleder Sand  
 Hard leder Zand  
 Cuero Arena

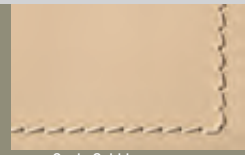

## NC

Noce Canaletto  
 Canaletto walnut  
 Noyer Canaletto  
 Canaletto Nußbaum  
 Notenhou Canaletto  
 Nogal Canaletto



## QC

Cuoio Cognac  
 Cognac Hide  
 Cuir Cognac  
 Hartleder Cognac  
 Hard leder Cognac  
 Cuero Cognac



## RN

Rovere Naturale  
 Oak  
 Eiche  
 Eikenhout  
 Rouvre  
 Roble Natural

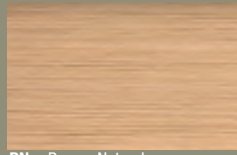

## QT

Cuoio Testa di Moro  
 Dark Brown Hide  
 Cuir Marron Foncé  
 Hartleder Dunkelbraun  
 Hard leder Donkerbruin  
 Cuero Cabeza de Moro

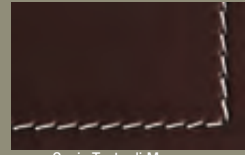

## BL

Bianco  
 White  
 Blanc  
 Weiß  
 Wit  
 Blanco

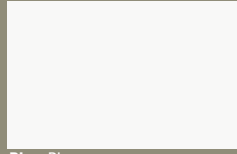

## QA

Cuoio Titanio  
 Titanio Hide  
 Cuir Titanio  
 Hartleder Titanio  
 Hard leder Titanio  
 Cuero Titanio

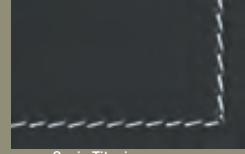

## HL

Laminato bianco lucido  
 Glossy white laminated  
 Lamifié blanc brillant Glänzende Lamelliert  
 Weiß  
 Glazend galamineerd wit  
 Laminado blanco pulido

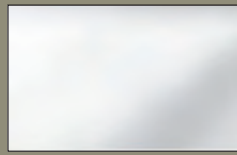

## QN

Cuoio Nero  
 Black Hide  
 Cuir Noir  
 Hartleder Schwarz  
 Hard leder Zwart  
 Cuero Negra

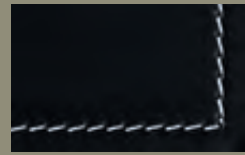



FRONTALI E FIANCHI DI CHIUSURA  
FRONTS AND CLOSING SIDES  
FAÇADES ET FLANCS DE FERMETURE  
FRONTBLENDEN UND ABSCHLUSSFLANKEN  
FRONTSTUKKEN EN ZISPANELEN  
FRONTALES Y COSTADOS DE CIERRE

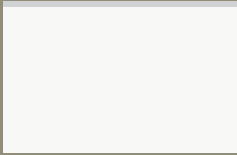

**LB** Laccato Bianco  
White Lacquered  
Laqué Blanc  
Weiß Lackiert  
Wit Gelakt  
Laqueado Blanco

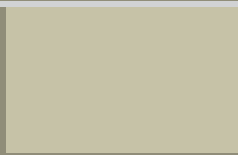

**L3** Laccato Nebbia  
Fog Lacquered  
Laqué Brouillard  
Nebel Lackiert  
Mist Lak  
Lacado Niebla



**L2** Laccato Tortora  
Tortora Lacquered  
Laqué Tortora  
Tortora Lackiert  
Tortora Lak  
Lacado Tortora



**L4** Laccato Titanio  
Titanio Lacquered  
Laqué Titanio  
Titanio Lackiert  
Titanio Lak  
Lacado Titanio

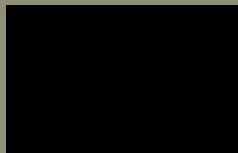

**LN** Laccato Nero  
Black Lacquered  
Laqué Noir  
Schwarzlackiert  
Zwart Gelakt  
Laqueado Negro

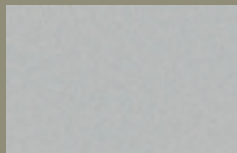

**LA** Laccato Alluminio  
Aluminium Lacquered  
Laqué Aluminium  
Aluminium Lackiert  
Aluminium Gelakt  
Laqueado Aluminio



**LQ** Laccato Tangerine  
Tangerine Lacquered  
Laqué Tangerine  
Tangerine Lackiert  
Tangerine Lak  
Lacado Tangerine



**LJ** Laccato Giallo Gold  
Giallo Gold Lacquered  
Laqué Giallo Gold  
Giallo Gold Lackiert  
Giallo Gold Lak  
Lacado Giallo Gold



**LF** Laccato Verde Natura  
Verde Natura Lacquered  
Laqué Verde Natura  
Verde Natura Lackiert  
Verde Natura Lak  
Lacado Verde Natura



**L5** Laccato Oceano  
Oceano Lacquered  
Laqué Oceano  
Oceano Lackiert  
Oceano Lak  
Lacado Oceano

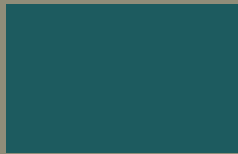

**LE** Laccato Deep Teal  
Deep Teal Lacquered  
Laqué Deep Teal  
Deep Teal Lackiert  
Deep Teal Lak  
Lacado Deep Teal



**LR** Laccato Rosso Bordeaux  
Bordeaux Lacquered  
Laqué Bordeaux  
Bordeaux Lackiert  
Bordeau Gelakt  
Laqueado Burdeos

# Sense & Sensibility

A.D. e progettazione grafica: [pubblicom@euosito.com](mailto:pubblicom@euosito.com)  
Foto: Fotogramma di Roberto Lughì  
Immagini renderizzate: Virtual Design  
Stampa: Eurotipo - Ottobre 2012

Particolari tecnici, estetici, finiture o altro possono essere modificati senza preavviso.  
Product details, aesthetics, finishes or other data may be subject to change without notice.



## **BRALCO srl**

### **Italy**

30030 Peseggia di Scorzé (VE) Via Nuova Moglianese, 1  
Tel. +39 041 448549 - Fax +39 041 5839246  
info@bralco.it - www.bralcosrl.com

### **France:**

Tel. +33 04 66 75 24 79 - Fax +33 04 66 75 12 78  
py.lagencelf@orange.fr

### **U.K. - Ireland:**

Mobile +44 7710 459516 - Fax +44 1279445601  
mark.s@bralco.it

### **Belgium - Luxemburg:**

Tel. +32 92438944 - Fax +32 92438949  
robin.v@bralco.it

### **Holland:**

Tel +31 623298472 - Fax +31 736313155  
info@elros.nl

### **Germany:**

Tel. +49 6022263690 - Fax +49 6022263693  
ralf.wastl@t-online.de

Tel.: +49 351-40 29 510 - Fax: +49 351-40 29 254

Vodafone: +49-172-9464933

(06/99/98/07/08/09/04/01/02/03)

lwb@lwb-floeha.de

### **Spain:**

Tel. +34 961 220110 - Fax +34 961 262761  
ramontarazona@telefonica.net

### **Middle East:**

Tel. +971 503358208  
Tel. +39 335 5485596  
epa.internationalssupplies@gmail.com

### **East Countries:**

Tel. +39 349 5835198  
tavinof@live.it